

MADE
IN THE **USA** 

mac
MEDICAL

Quality Built, American Made

Medical Equipment

INSPIRED
TO
BE BETTER

2024 Product Catalog

www.macmedical.com



About Us

MAC Medical, Inc. manufactures top quality medical equipment including Warming Cabinets, Sinks, Tables, Casework, Case Carts, IV Stands, Mayo Stands, Linen Hampers, and many other stainless steel products. To complement our stainless steel products, we have expanded our product line to include Plastic Laminate Casework and carts for a variety of spaces including medical, dental, laboratory, and more.

Over the last two decades, MAC Medical has grown to more than 140 full-time employees operating in a 122,500 square foot manufacturing facility and 48,500 square foot corporate office. Both facilities are located in Southern Illinois making this an ideal place for centralized distribution to the entire United States. Not limited to the United States, MAC Medical has product in over 20 countries worldwide.

Founded as a solutions-based company, MAC Medical still maintains that as its core competency. With no project too large or too small, MAC Medical is committed to providing solutions for customer needs with its superior service and American made products.

Customer needs are our first priority.



Corporate Office
2021

Columbia, IL

Corporate Office
200 Admiral Weinel Boulevard
Columbia, Illinois 62236

Manufacturing Plant
820 South Mulberry Street
Millstadt, Illinois 62260

Phone: 618-476-3550
Toll Free: 877-828-9975
Fax: 618-476-3337
sales@macmedical.com
www.macmedical.com



Plant Expansion
2019

Millstadt, IL



@macmedicalinc



Manufacturing Plant
2005

Millstadt, IL



First Shop
1999

Belleville, IL



A philosophy, a mindset, a mission statement...whatever you want to call it, our employees at MAC Medical are "Inspired To Be Better". It's this mentality that helps us to provide the quality built, American made products that our customers have come to expect.

Call Toll Free: 877-828-9975

Table of Contents

Blanket & Fluid Warming Cabinets	2	Mobile Medical Carts	42
D-Series (Data Logging) Overview	4	Short Mobile Carts	43
TS-Series (Touch Screen) Overview	5	Tall Mobile Carts	44
Single Chamber Units	6	Mobile Cart Accessories	45
Dual Chamber Units	7		
Triple Chamber Units	8	Stainless Steel Tables	46
Warming Cabinet Accessories	8	Instrument Tables	47
D-Series vs. TS-Series Comparison	9	Utility Tables	48
D-Series Options & How to Order	10	Nested Tables	48
TS-Series Options & How to Order	11	Work Tables	49
		Space Saver Tables	49
Transport Stretchers	12	Adjustable Over Operating Tables	50
General Transport Stretcher	13	Central Supply Tables	50
5th Wheel Transport Stretcher	14	Prep & Pack Workstations	51
Stretcher Comparison	15		
		Stainless Steel Stands	52
Stainless Steel Sinks	16	Mayo Stands	53
Surgical Scrub Sinks (ES-Series)	17	IV Stands	54
Surgical Scrub Sinks (SS-Series)	19	Solution Stands	55
Processing Sinks	20		
		Other Stainless Steel Products	56
Stainless Steel Casework & Cabinets	22	Linen Hampers	57
Wall Cabinets	24	Gowning Benches	58
Base Cabinets	24	Step Stools	58
High Cabinets	24	Kick Buckets	59
Operating Room Cabinets	25	Pass Through Windows	59
Casework Accessories	26	Stationary Wall Shelves	60
Mobile Cabinets	27	Fold Down Wall Shelves	60
Nurses Documentation Stations	28	Peg Boards	61
Scope Cabinets	29		
		Quick Ship Program	62
Plastic Laminate Casework	30	Green Initiative	64
Thermally Fused Laminate (TFL)	31	Warranty Information	65
High Pressure Laminate (HPL)	32	Contact Us	66
Vinyl Foil Laminate (3DL)	32		
Typical Groupings	33		
Stainless Steel Carts	34		
Closed Case Carts	35		
Open Case Carts	36		
Vertical Handle Case Carts	37		
Sealed Case Carts	38		
Utility Carts	39		
Supply Carts	40		
Sterilizer Carts	40		
Sterile Wrap Carts	41		



Blanket & Fluid Warming Cabinets

We offer a variety of Blanket & Fluid Warming Cabinets to help compliment and enhance your facility. As with all of our products, warming cabinets undergo stringent testing procedures during the manufacturing process to assure a long life, the highest quality, and accurate temperature settings. We offer standard sizes along with custom sizes to meet specific requirements.



D-Series

Data Logging
Warming Cabinets



TS-Series

Touch Screen
Warming Cabinets

MAC Medical, Inc. is proud to offer both our D-Series (Data Logging) and TS-Series (Touch Screen) Blanket & Fluid Warming Cabinets. Both series provide the perfect blend of technology, value, and customer support in the industry.

The D-Series Warming Cabinets are the most user-friendly temperature recording devices on the market today. These warmers are equipped with independent, digitally controlled heating chambers that offer actual temperature and set point displays. The Ethernet/Wi-Fi capable TS-Series Warming Cabinets offer unparalleled technology by allowing remote connectivity to your warmer (via smart phone app) and giving you control of your warmer wherever you are.

The D-Series is available in single, dual, and triple chamber units, while the TS-Series is available in single and dual chamber units. Both series require no additional software, and have many optional features to choose from.

D-Series Warming Cabinets

The D-Series (Data Logging) Warming Cabinets provide independent, digitally controlled heating chambers that offer actual temperature and set point displays. Data is recorded every 30 minutes and stored for up to two years. Choose from single, dual, or triple chamber units.



DWC243074E-G-4B
(shown with optional glass doors)

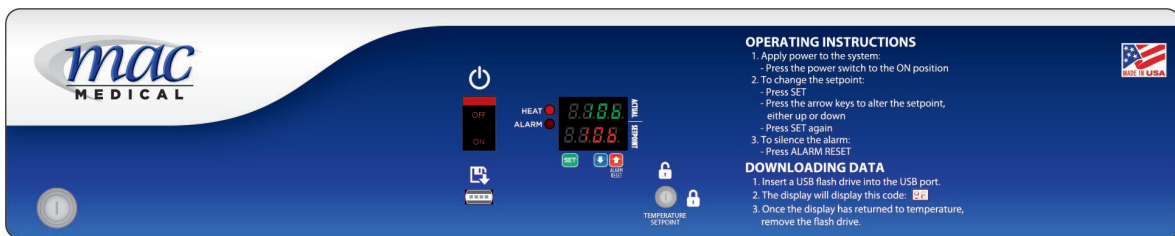

D-Series Header Control (Single Chamber)

STANDARD FEATURES

- "Easy Log" integrated data logger with removable USB
- Keyed temperature lock out
- Keyed door lock for single & upper chamber units
- Adjustable feet
- Stainless steel doors
- Automatically records data every 30 minutes
- Internal storage up to 2 years
- Displays actual temperature and set points at all times
- Independent digitally controlled heating chambers
- Rapid warm time (2-6 hours depending on load)
- Push button digital operation
- Large digital display(s)
- Fully insulated to provide uniform heating
- Audible & visual over-temp alarm

OPTIONAL FEATURES

- Full view glass door
- Left hand door hinge
- 220/240V power supply
- Celsius
- Two (2) recessed unit options
- Seismic braces
- Pass through chamber
- Electronic keypad lock
- Sloping top
- Keyed door lock for intermediate & lower chamber units
- Custom sizes available

To Download Data

1. Insert supplied USB flash drive into USB slot.
2. Data download will automatically begin.
3. During download display will read:



4. Once the display shows the temperature again, it is safe to remove the flash drive.
5. Data is saved on the flash drive as a .CSV file for easy import into most spreadsheet programs (e.g. Microsoft Excel).
6. Data is secure (no reporting or connection to any network).

Sample Report

SWC243074 Single, S/N: 062112-D01, 101118

DATE/TIME	TEMPERATURE	°C/°F
10/10/2018 23:12	106	F
10/10/2018 23:43	106	F
10/11/2018 0:12	106	F
10/11/2018 0:43	106	F
10/11/2018 1:12	106	F

Premium Upgrade

TS-Series

Warming Cabinets

The Ethernet/Wi-Fi capable TS-Series (Touch Screen) Warming Cabinets offer unparalleled technology by allowing remote connectivity to your warmer (via smart phone app) and giving you control of your warmer wherever you are. Choose from single or dual chamber units.



SMART

technology



DWC243074T-TS-G-4B
(shown with optional glass doors and roll out baskets)



TS-Series Header Control (Single & Dual Chambers)

STANDARD FEATURES

Many of the same features as the D-Series, but also includes:

- Intuitive touch screen control
- Intuitive software (supports multiple languages)
- Data logging with digital signatures
- Electronic temperature lock out
- View live trends
- Alarm logging
- Multi-level user security
- Operator audit trail
- Built in Ethernet
- Wi-Fi capable (router to be supplied by end user)
- Remote monitoring & control (VNC)
- Remote tech support & diagnostics
- Text and email alarm notifications
- File transfer via USB or FTP web page
- Smart phone/device access

OPTIONAL FEATURES

- Full view glass door
- Left hand door hinge
- 220/240V power supply
- Celsius
- Two (2) recessed unit options
- Seismic braces
- Pass through chamber
- Electronic keypad lock
- Sloping top
- Keyed door lock for lower chamber units
- Custom sizes available

Check on the status of your warmer(s) with your smart phone device



Manage multiple warmers remotely or locally, via Ethernet or Wi-Fi (router for Wi-Fi to be supplied by end user)



Optional roll out basket makes organization and item selection easy. Cool touch handles keep your hands from getting burned.

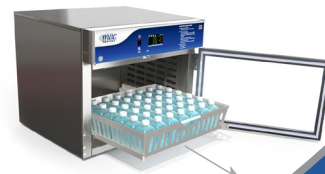

Single Chamber Units

Blanket & Fluid Warming Cabinets

SWC151822 (D-Series only)

Overall Dimensions

17.25"D x 18"W x 22"H
(438.15mm x 457.2mm x 558.8mm)
Optional Adjustable Shelf

Chamber I.D.

14"D x 14"W x 11.63"H
(355.6mm x 355.6mm x 259.4mm)
1.30 Cubic Feet Storage
Temperature Range 90°-160° F (Tolerance +/- 1° F)

Electrical

120V, 2.08 Amp, 50/60 Hz, .25 kWh (Avg.),
853 BTU/hr (Avg.)



SWC151822-G-NB
No base (NB) standard for this model

Additional items available for this model (sold separately):

- Mobile Stand (MS1518)
- Mobile Cabinet Stand (WBC1518)
- Roll Out Basket (WB1518)

SWC182424 (D-Series) SWC182424-TS (TS-Series)

Overall Dimensions

20.5"D x 24"W x 24.5"H
(520.7mm x 609.6mm x 622.3mm)
Optional Adjustable Shelf

Chamber I.D.

17"D x 20"W x 15.25"H
(431.8mm x 508mm x 387.3mm)
3.0 Cubic Feet Storage
Temperature Range 90°-160° F (Tolerance +/- 1° F)

Electrical

120V, 2.9 Amp, 50/60 Hz, .23 kWh (Avg.),
785 BTU/hr (Avg.)



SWC182424-G-NB
No base (NB) standard for this model

Additional items available for this model (sold separately):

- Mobile Stand (MS1824)
- Mobile Cabinet Stand (WBC1824)
- Roll Out Basket (WB1824)

SWC243024 (D-Series) *Best Seller!* SWC243024-TS (TS-Series)

Overall Dimensions

26.5"D x 30"W x 24.5"H
(673.1mm x 762mm x 622.3mm)
1 Adjustable Shelf

Chamber I.D.

23"D x 26"W x 15.25"H
(584.2mm x 660.4mm x 387.3mm)
5.27 Cubic Feet Storage
Temperature Range 90°-160° F (Tolerance +/- 1° F)

Electrical

120V, 6.3 Amp, 50/60 Hz, .45 kWh (Avg.),
1535 BTU/hr (Avg.)



SWC243024-G-NB
No base (NB) standard for this model

Additional items available for this model (sold separately):

- Mobile Stand (MS2430)
- Mobile Cabinet Stand (WBC2430)
- Roll Out Basket (WB2430)

SWC243036 (D-Series) SWC243036-TS (TS-Series)

Overall Dimensions

26.5"D x 30"W x 36.5"H
(673.1mm x 762mm x 927mm)
2 Adjustable Shelves

Chamber I.D.

23"D x 26"W x 25"H
(584.2mm x 660.4mm x 635mm)
8.65 Cubic Feet Storage
Temperature Range 90°-160° F (Tolerance +/- 2° F)

Electrical

120V, 6.3 Amp, 50/60 Hz, .45 kWh (Avg.),
1535 BTU/hr (Avg.)



SWC243036-G-2B
2" base (2B) standard for this model

Additional items available for this model (sold separately):

- Mobile Stand (MS2430)
- Mobile Cabinet Stand (WBC2430)
- Roll Out Basket (WB2430)

SWC182474 (D-Series) SWC182474-TS (TS-Series)

Overall Dimensions

20.5"D x 24"W x 75"H
(520.7mm x 609.6mm x 1905mm)
2 Adjustable Shelves, 1 Fixed Shelf

Chamber I.D.

17"D x 20"W x 61"H
(431.8mm x 508mm x 1549mm)
12.0 Cubic Feet Storage
Temperature Range 90°-160° F (Tolerance +/- 3° F)

Electrical

120V, 6.5 Amp, 50/60 Hz, .47 kWh (Avg.),
1604 BTU/hr (Avg.)



SWC182474-G-4B
4" base (4B) standard for this model

Additional items available for this model (sold separately):

- Mobile Base (MB1824)
- Roll Out Basket (WB1824)

SWC243074 (D-Series) *Best Seller!* SWC243074-TS (TS-Series)

Overall Dimensions

26.5"D x 30"W x 74.5"H
(673.1mm x 762mm x 1892mm)
2 Adjustable Shelves, 1 Fixed Shelf

Chamber I.D.

23"D x 26"W x 61"H
(584.2mm x 660.4mm x 1549mm)
21.1 Cubic Feet Storage
Temperature Range 90°-160° F (Tolerance +/- 3° F)

Electrical

120V, 6.5 Amp, 50/60 Hz, .47 kWh (Avg.),
1604 BTU/hr (Avg.)



SWC243074-G-4B
4" base (4B) standard for this model

Additional items available for this model (sold separately):

- Mobile Base (MB2430)
- Roll Out Basket (WB2430)

Dual Chamber Units

Blanket & Fluid Warming Cabinets

DWC183074T (D-Series)
DWC183074T-TS (TS-Series)
 (T = Chambers in Thirds)

Overall Dimensions

20.5"D x 30"W x 74.5"H
 (520.7mm x 762mm x 1892mm)
 12.27 Cubic Feet Storage, 3 Adjustable Shelves

Upper Chamber I.D.

17"D x 26"W x 15.25"H
 (431.8mm x 660.4mm x 387.3mm)
 3.45 Cubic Feet Storage
 Temperature Range 90°-160° F (Tolerance +/- 1° F)

Lower Chamber I.D.

17"D x 26"W x 34.5"H
 (431.8mm x 660.4mm x 876.3mm)
 8.82 Cubic Feet Storage
 Temperature Range 90°-160° F (Tolerance +/- 2° F)

Electrical

120V, 8.3 Amp, 50/60 Hz, .82 kWh (Avg.),
 2047 BTU/hr (Avg.)



DWC183074T-G-4B
 4" base (4B) standard for this model

Additional items available for this model (sold separately):

- Mobile Base (MB1830)
- Roll Out Basket (WB1830)

DWC243074T (D-Series) *Best Seller!*
DWC243074T-TS (TS-Series)
 (T = Chambers in Thirds)

Overall Dimensions

26.5"D x 30"W x 74.5"H
 (673.1mm x 762mm x 1892mm)
 17.21 Cubic Feet Storage, 3 Adjustable Shelves

Upper Chamber I.D.

23"D x 26"W x 15.25"H
 (584.2mm x 660.4mm x 387.3mm)
 5.28 Cubic Feet Storage
 Temperature Range 90°-160° F (Tolerance +/- 1° F)

Lower Chamber I.D.

23"D x 26"W x 34.5"H
 (584.2mm x 660.4mm x 876.3mm)
 11.93 Cubic Feet Storage
 Temperature Range 90°-160° F (Tolerance +/- 3° F)

Electrical

120V, 12.5 Amp, 50/60 Hz, .90 kWh (Avg.),
 3071 BTU/hr (Avg.)



DWC243074T-G-4B
 4" base (4B) standard for this model

Additional items available for this model (sold separately):

- Mobile Base (MB2430)
- Roll Out Basket (WB2430)

DWC243074E (D-Series)
DWC243074E-TS (TS-Series)
 (E = Equal Chambers)

Overall Dimensions

26.5"D x 30"W x 74.5"H
 (673.1mm x 762mm x 1892mm)
 17.64 Cubic Feet Storage, 4 Adjustable Shelves

Upper Chamber I.D.

23"D x 26"W x 25"H
 (584.2mm x 660.4mm x 635mm)
 8.65 Cubic Feet Storage
 Temperature Range 90°-160° F (Tolerance +/- 2° F)

Lower Chamber I.D.

23"D x 26"W x 26"H
 (584.2mm x 660.4mm x 660.4mm)
 8.99 Cubic Feet Storage
 Temperature Range 90°-160° F (Tolerance +/- 2° F)

Electrical

120V, 12.5 Amp, 50/60 Hz, .90 kWh (Avg.),
 3071 BTU/hr (Avg.)



DWC243074E-G-4B
 4" base (4B) standard for this model

Additional items available for this model (sold separately):

- Mobile Base (MB2430)
- Roll Out Basket (WB2430)

Optional
Mobile Cabinet Stand

Available for 36"H & smaller
 single chamber models

Contact Us

Contact our customer service department toll free at **877-828-9975**, or by email at sales@macmedical.com.



Triple Chamber Units

Blanket & Fluid Warming Cabinets

TWC183078 (D-Series only)

Overall Dimensions

20.5"D x 30"W x 78.75"H
(520.7mm x 762mm x 2000mm)
10.36 Cubic Feet Storage, 1 Adjustable Shelf

Upper Chamber I.D.

17"D x 26"W x 11.25"H
(431.8mm x 660.4mm x 285.7mm)
2.88 Cubic Feet Storage
Temperature Range 90°-110° F (Tolerance +/- 1° F)

Intermediate Chamber I.D.

17"D x 26"W x 10.75"H
(431.8mm x 660.4mm x 273mm)
2.75 Cubic Feet Storage
Temperature Range 90°-150° F (Tolerance +/- 1° F)

Lower Chamber I.D.

17"D x 26"W x 18.5"H
(431.8mm x 660.4mm x 469.9mm)
4.73 Cubic Feet Storage
Temperature Range 90°-160° F (Tolerance +/- 1° F)

Electrical

120V, 12.9 Amp, 50/60 Hz, .90 kWh (Avg.),
3071 BTU/hr (Avg.)



TWC183078-G-4B
4" base (4B) standard for this model

Additional items available for this model (sold separately):

- Mobile Base (MB1830)
- Roll Out Basket (WB1830)

TWC243078 (D-Series only)

Overall Dimensions

26.5"D x 30"W x 78.75"H
(673.1mm x 762mm x 2000mm)
14.01 Cubic Feet Storage, 1 Adjustable Shelf

Upper Chamber I.D.

23"D x 26"W x 11.25"H
(584.2mm x 660.4mm x 285.7mm)
3.89 Cubic Feet Storage
Temperature Range 90°-110° F (Tolerance +/- 1° F)

Intermediate Chamber I.D.

23"D x 26"W x 10.75"H
(584.2mm x 660.4mm x 273mm)
3.72 Cubic Feet Storage
Temperature Range 90°-150° F (Tolerance +/- 1° F)

Lower Chamber I.D.

23"D x 26"W x 18.5"H
(584.2mm x 660.4mm x 469.9mm)
6.4 Cubic Feet Storage
Temperature Range 90°-160° F (Tolerance +/- 1° F)

Electrical

120V, 12.9 Amp, 50/60 Hz, .90 kWh (Avg.),
3071 BTU/hr (Avg.)



TWC243078-G-4B
4" base (4B) standard for this model

Additional items available for this model (sold separately):

- Mobile Base (MB2430)
- Roll Out Basket (WB2430)

Warming Cabinet Accessories



Mobile Stands	
Model #	Overall Dimensions
MS1518	18"D x 21"W x 34"H
MS1824	20"D x 28"W x 34"H
MS1830	20"D x 34"W x 34"H
MS2424	26"D x 26"W x 34"H
MS2430	26"D x 34"W x 34"H

Mobile Cabinet Stands	
Model #	Overall Dimensions
WBC1518	18"D x 21"W x 34"H
WBC1824	20"D x 28"W x 34"H
WBC1830	20"D x 34"W x 34"H
WBC2424	26"D x 26"W x 34"H
WBC2430	26"D x 34"W x 34"H

Mobile Bases	
Model #	Overall Dimensions
MB1824	22"D x 27"W x 6.75"H
MB1830	22"D x 33"W x 6.75"H
MB2424	28"D x 27"W x 6.75"H
MB2430	28"D x 33"W x 6.75"H

Roll Out Baskets	
Model #	Overall Dimensions
WB1518	11.88"D x 10.25"W x 5"H
WB1824	16"D x 16.92"W x 5"H
WB1830	15.88"D x 22.98"W x 5"H
WB2424	21.75"D x 16.98"W x 5"H
WB2430	21.75"D x 23.10"W x 5"H

Note: All warming cabinet mobile stands, mobile cabinet stands, mobile bases, and roll out baskets are sold separately.

Which **Warming Cabinet** is right for *your* facility?



D-Series vs. TS-Series Comparison Chart

Standard Features	D-Series (Data Logging)	TS-Series (Touch Screen)
"Easy Log" Integrated data logger with removable USB	X	X
Keyed temperature lock out	X	X
Keyed door lock for single & upper chamber units	X	X
Adjustable feet	X	X
Stainless steel doors	X	X
Automatically records data every 30 minutes	X	X
Internal storage up to 2 years	X	X
Displays actual temperature and set points at all times	X	X
Independent digitally controlled heating chambers	X	X
Rapid warm time (2-6 hours depending on load)	X	X
Push button digital operation	X	X
Large digital display(s)	X	X
Fully insulated to provide uniform heating	X	X
Audible & visual over-temp alarm	X	X
Intuitive touch screen control		X
Intuitive software (supports multiple languages)		X
Data logging with digital signatures		X
Electronic temperature lock out		X
View live trends		X
Alarm logging		X
Multi-level user security		X
Operator audit trail		X
Built in Ethernet & Wi-Fi capable		X
Remote monitoring & control (VNC) via smart phone		X
Remote tech support & diagnostics		X
Text & email alarm notifications		X
File transfer via USB or FTP web page		X
Smart phone/device access		X
Optional Features & Accessories	D-Series (Data Logging)	TS-Series (Touch Screen)
Full view glass door	X	X
Left hand door hinge	X	X
Mobile base, mobile stand, or mobile cabinet stand	X	X
220/240V power supply	X	X
Celsius	X	X
Two (2) recessed unit options	X	X
Seismic braces	X	X
Roll out basket with cool touch handles	X	X
Pass through chamber	X	X
Electronic keypad lock	X	X
Sloping top	X	X
Keyed door lock for lower chambers*	X	X
Keyed door lock for intermediate chambers**	X	X
Custom sizes available	X	X

* Only available for Dual and Triple Chamber Units

** Only available for Triple Chamber Units

D-Series Options

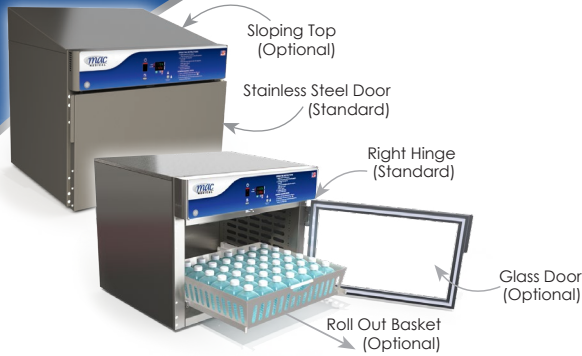

Door Types

- Stainless Steel (Standard)
- Glass

Door Hinges

- Right (Standard) • Left

Base Styles

- 2" • 4" • 6" • No Base

Note: Additional shelving available for purchase

Options & Accessories

- 220/240V Power Supply
- Celsius
- Two (2) Recessed Unit Options:
 - R1 = Insulation Wrap, No Top Panel, No Side Panels, and No Trim Kit
 - R2 = Top Panel, Side Panels, and Trim Kit
- Seismic Braces
- Mobile Stand
- Mobile Cabinet Stand
- Mobile Base
- Roll Out Basket
- Pass Through Chamber
- Electronic Keypad Lock
- Sloping Top
- Intermediate Chamber Door Lock (only available for Triple Chamber Units)
- Lower Chamber Door Lock (only available for Dual and Triple Chamber Units)

How to Order D-Series

Base Model #	Overall Size	Chambers	Door Type	Door Hinge	Base Style	Other Options	
SWC151822	17.25"D x 18"W x 22"H	Single	G = Glass Door	LH = Left Hinge	2B = 2" Base	220 = 220/240V Power Supply C = Celsius R1 = Recessed Unit with Insulation Wrap, No Top Panel, No Side Panels, and No Trim Kit R2 = Recessed Unit with Top Panel, Side Panels, and Trim Kit SB = Seismic Braces WB = Roll Out Basket P = Pass Through Chamber EL = Electronic Keypad Lock ST = Sloping Top IDL = Intermediate Chamber Door Lock (Only available for Triple Chamber Units) LDL = Lower Chamber Door Lock (Only available for Dual & Triple Chamber Units)	
SWC182424	20.5"D x 24"W x 24.5"H	Single	Blank = Stainless Steel Door (Standard)	Blank = Right Hinge (Standard)	4B = 4" Base		
SWC243024	26.5"D x 30"W x 24.5"H	Single			6B = 6" Base		
SWC243036	26.5"D x 30"W x 36.5"H	Single			NB = No Base		
SWC182474	20.5"D x 24"W x 75"H	Single					
SWC243074	26.5"D x 30"W x 74.5"H	Single					
DWC183074T*	20.5"D x 30"W x 74.5"H	Dual			MB = Mobile Base		
DWC243074T*	26.5"D x 30"W x 74.5"H	Dual					
DWC243074E**	26.5"D x 30"W x 74.5"H	Dual					
TWC183078	20.5"D x 30"W x 78.75"H	Triple					
TWC243078	26.5"D x 30"W x 78.75"H	Triple					

* T = Chambers in Thirds

** E = Equal Chambers

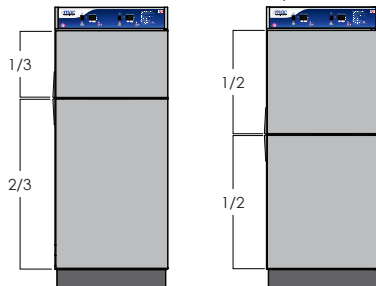

Example 1: Model # DWC243074E, Stainless Steel Door, Right Hinge, 4" Base, Celsius, Lower Chamber Door Lock = Order Model # DWC243074E-4B-C-LDL

Example 2: Model # SWC182474, Glass Door, Left Hinge, Sloping Top, Mobile Base = Order Model # SWC182474-G-LH-ST-MB

Note: Model # will change based on features added



TS-Series Options

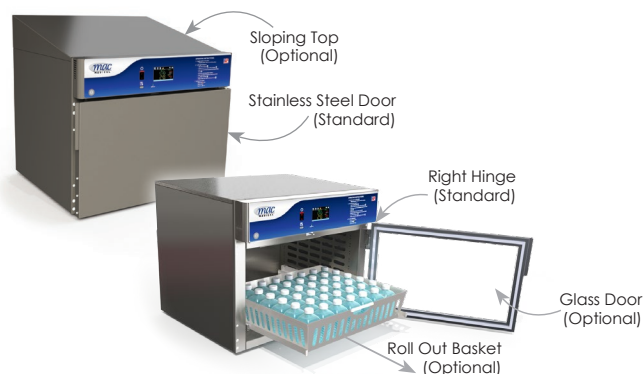

Door Types

- Stainless Steel (Standard)
- Glass

Door Hinges

- Right (Standard) • Left

Base Styles

- 2" • 4" • 6" • No Base

Note: Additional shelving available for purchase

Options & Accessories

- 220/240V Power Supply
- Celsius
- Two (2) Recessed Unit Options:
 - R1 = Insulation Wrap, No Top Panel, No Side Panels, and No Trim Kit
 - R2 = Top Panel, Side Panels, and Trim Kit
- Seismic Braces
- Mobile Stand
- Mobile Cabinet Stand
- Mobile Base
- Roll Out Basket
- Pass Through Chamber
- Electronic Keypad Lock
- Sloping Top
- Lower Chamber Door Lock (only available for Dual Chamber Units)

How to Order TS-Series						
Base Model #	Overall Size	Chambers	Door Type	Door Hinge	Base Style	Other Options
SWC182424-TS	20.5"D x 24"W x 24.5"H	Single	G = Glass Door Blank = Stainless Steel Door (Standard)	LH = Left Hinge Blank = Right Hinge (Standard)	2B = 2" Base 4B = 4" Base 6B = 6" Base NB = No Base MB = Mobile Base	220 = 220/240V Power Supply
SWC243024-TS	26.5"D x 30"W x 24.5"H	Single				C = Celsius
SWC243036-TS	26.5"D x 30"W x 36.5"H	Single				R1 = Recessed Unit with Insulation Wrap, No Top Panel, No Side Panels, and No Trim Kit
SWC182474-TS	20.5"D x 24"W x 75"H	Single				R2 = Recessed Unit with Top Panel, Side Panels, and Trim Kit
SWC243074-TS	26.5"D x 30"W x 74.5"H	Single				SB = Seismic Braces
DWC183074T-TS*	20.5"D x 30"W x 74.5"H	Dual				WB = Roll Out Basket
DWC243074T-TS*	26.5"D x 30"W x 74.5"H	Dual				P = Pass Through Chamber
DWC243074E-TS**	26.5"D x 30"W x 74.5"H	Dual				EL = Electronic Keypad Lock
						ST = Sloping Top
						LDL = Lower Chamber Door Lock (Only available for Dual Chamber Units)

SMART
technology

* T = Chambers in Thirds

** E = Equal Chambers

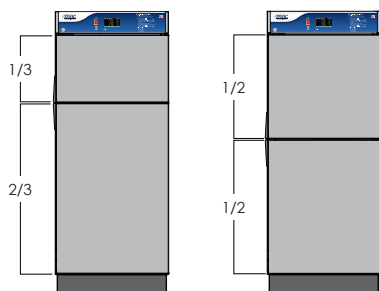

Example 1: Model # DWC243074E-TS, Stainless Steel Door, Right Hinge, 4" Base, Celsius, Lower Chamber Door Lock = Order Model # DWC243074E-TS-4B-C-LDL

Example 2: Model # SWC182474-TS, Glass Door, Left Hinge, Sloping Top, Mobile Base = Order Model # SWC182474-TS-G-LH-ST-MB

Note: Model # will change based on features added





Transport Stretchers

Our Transport Stretchers are designed to ensure safety and efficiency while offering the best blend of features, value, ergonomics, and customer support in the industry. A variety of standard and optional features provide optimal patient comfort & transport.

Best Seller!

PT1001

General Transport Stretcher

Economical and versatile, the PT1001 is an ideal solution for any department where cost efficient quality is required. The PT1001 allows for easy and comfortable patient transfer with an increased weight capacity of up to 750 lbs.



750
POUND
Weight
Capacity

STANDARD FEATURES

- 750 lb. weight capacity
- Height adjustment range: 22"–35" (bottom of mattress)
- Ergonomically located oxygen tank holder
- Effortless steering, pivoting, and cornering with 8" casters (1 directional & 3 swiveling)
- 6 brake/steer pedals
- Dual pedestal lift mechanism
- Lift/Trendelenburg pedals on both sides
- Trendelenburg & reverse Trendelenburg +/- 18°
- Dual Fowler assisted lift back rest with 90° adjustability
- Fold forward side rails with built in push handles
- 29" or 31" bed width
- 4" comfort mattress
- 2 hook removable telescopic IV pole
- 6 IV pole sockets available
- Large storage area underneath for patient belongings
- Full perimeter bumper to protect your walls and fixtures
- 4 restraint belt locations

OPTIONAL FEATURES

- 5th wheel add-on kit
- Fold down push handles
- Knee gatch
- Paper roll dispenser kit *
- Detachable foot board *
- Envelope style rail bumper pads *

* Additional lead time required (7-10 business days)

Model # will change based on features added

PT1001

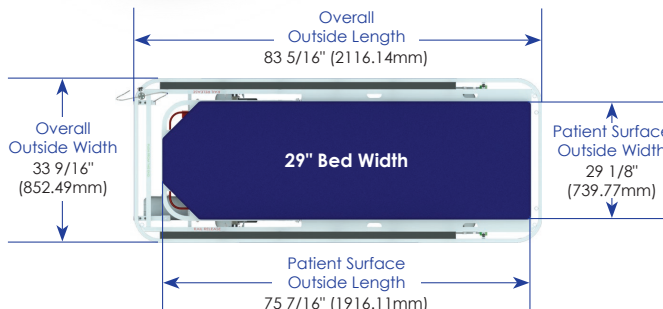

PT1001-31

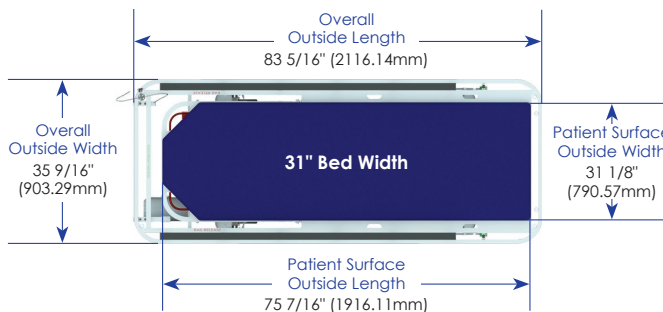

Height Adjustment Ranges (PT1001 & PT1001-31)

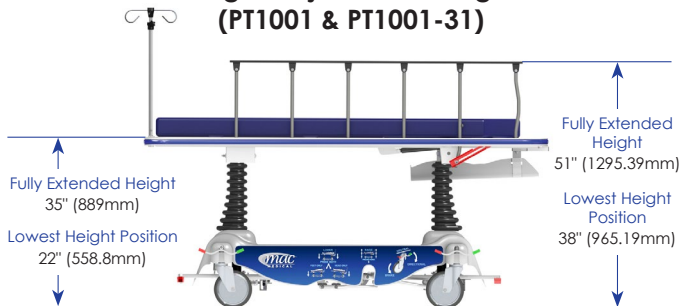

PTF1000

5th Wheel Transport Stretcher

The PTF1000 5th Wheel Transport Stretcher allows for easy and comfortable patient transfer with a weight capacity of up to 750 lbs. The retractable center fifth wheel combines effortless directional movement and cornering with 4 swiveling wheels for ease of use, control, and safety.



STANDARD FEATURES

- Retractable center fifth wheel provides effortless directional movement and cornering
- 750 lb. weight capacity
- Height adjustment range: 22"-35" (bottom of mattress)
- Ergonomically located oxygen tank holder
- Effortless steering, pivoting, and cornering with 8" casters (4 swiveling)
- 6 brake/steer pedals
- Dual pedestal lift mechanism
- Lift/Trendelenburg pedals on both sides
- Trendelenburg & reverse Trendelenburg +/- 18°
- Dual Fowler assisted lift back rest with 90° adjustability
- Fold forward side rails with built in push handles
- 29" or 31" bed width
- 4" comfort mattress
- 2 hook removable telescopic IV pole
- 6 IV pole sockets available
- Large storage area underneath for patient belongings
- Full perimeter bumper to protect your walls and fixtures
- 4 restraint belt locations

OPTIONAL FEATURES

- Fold down push handles
- Knee gatch
- Paper roll dispenser kit *
- Detachable foot board *
- Envelope style rail bumper pads *

* Additional lead time required (7-10 business days)
Model # will change based on features added

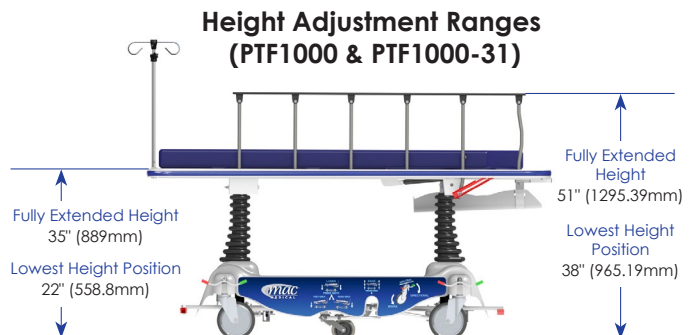
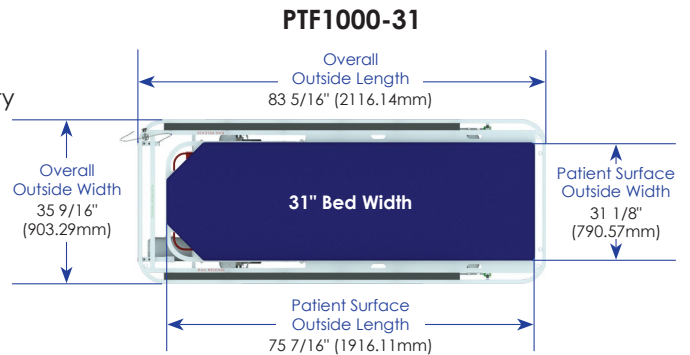
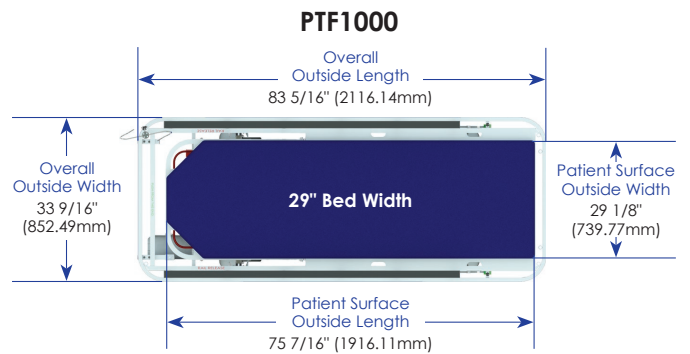

Which **Stretcher** is right for *your* facility?



Stretcher Comparison Chart		
Standard Features	PT1001	PTF1000
750 lb. weight capacity	X	X
Retractable center fifth wheel		X
Height adjustment range: 22"-35" (bottom of mattress)	X	X
Ergonomically located oxygen tank holder	X	X
8" casters (1 directional & 3 swiveling)	X	
8" casters (4 swiveling)		X
6 brake/steer pedals	X	X
Dual pedestal lift mechanism	X	X
Lift/Trendelenburg pedals on both sides	X	X
Trendelenburg & reverse Trendelenburg +/- 18°	X	X
Dual Fowler assisted lift back rest with 90° adjustability	X	X
Fold forward side rails with built in push handles	X	X
29" or 31" bed width	X	X
4" comfort mattress	X	X
2 hook removable telescopic IV pole	X	X
6 IV pole sockets available	X	X
Large storage area underneath for patient belongings	X	X
Perimeter bumper to protect your walls and fixtures	X	X
4 restraint belt locations	X	X
Optional Features	PT1001	PTF1000
5th wheel add-on kit	X	
Fold down push handles	X	X
Knee gatch	X	X
Paper roll dispenser kit*	X	X
Detachable foot board*	X	X
Envelope style rail bumper pads*	X	X

* Additional lead time required (7-10 business days)

Model # will change based on features added

Contact Us

Contact our customer service department toll free at **877-828-9975**, or by email at sales@macmedical.com.



Stainless Steel Sinks

Manufactured with the highest quality possible, we deliver a full line of fully functional sinks. Combining the best materials, components, and craftsmanship available, each sink is customized to each customer's specific needs.

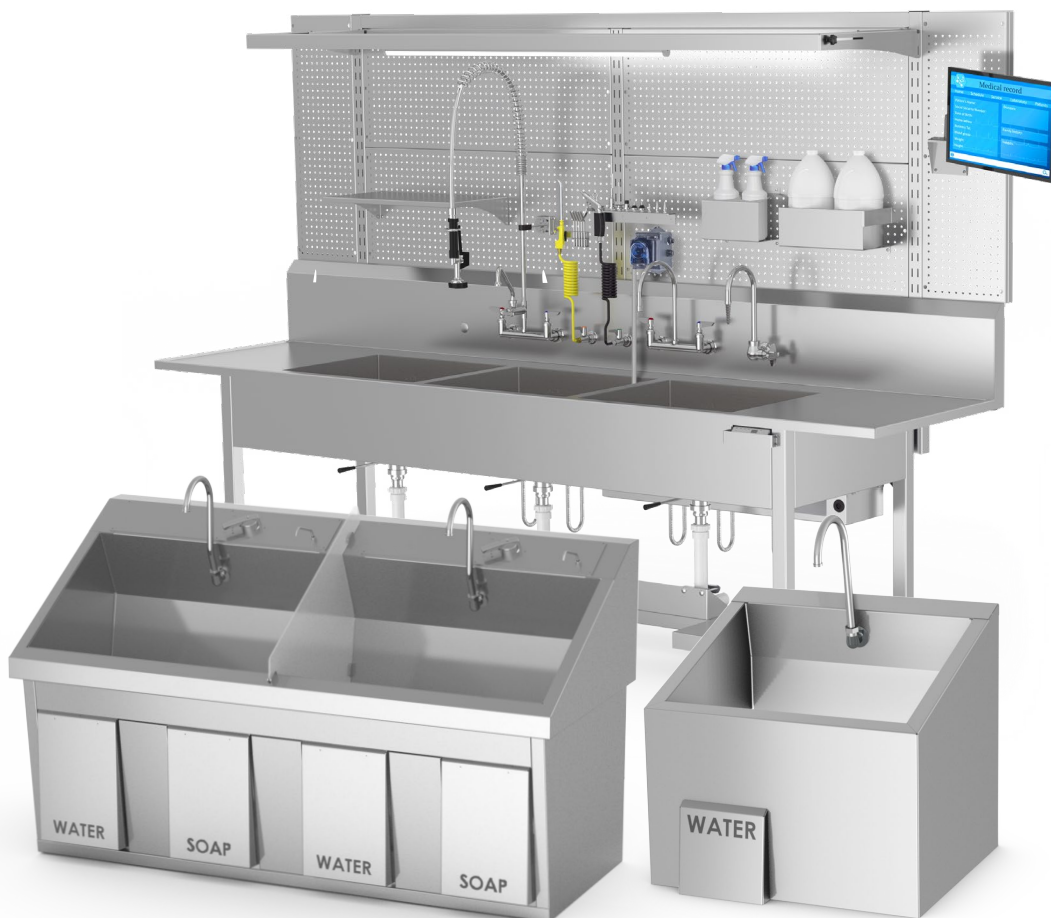

ES-Series

Surgical Scrub Sinks

Our ES-Series Surgical Scrub Sinks were developed to answer space and economical constraints where needed. These sinks have smaller outside dimensions compared to our SS-Series, but still maintain a deep basin to allow for proper scrubbing. The operation is the same as the SS-Series, however features do vary.



STANDARD FEATURES

- Single, dual, or triple stations
- Deep sloping basin
- Adjustable thermostatic controlled pressure regulating mixing valve (one per station, mounted under sink)
- Knee operated water (optional with IR sinks)
- High mount swivel gooseneck spout with adjustable swivel spray aerator
- Flow control valve
- Backflow preventers
- Infrared sinks are equipped with a 24 volt plug in transformer
- Z-brackets (see specifications on rear panel for wall support)
- 304 stainless steel polished and ground to a #4 finish

OPTIONAL FEATURES

- Infrared operation
- Manual bypass to add knee operated water with IR operation
- Knee operated soap
- Knee operated soap with IR water operation
- Foot operated water
- Foot operated soap
- Digital scrub timer
- Eye wash
- Thermostatic mixing valve (add on to eye wash option)
- Laminar flow
- 220/240V power supply
- Pedestal base

ES-Series Standard Models	
Base Model #	Overall Dimensions
ES25 (Single Station)	23.5"D x 25"W x 20.5"H
ES47 (Dual Station)	23.5"D x 47"W x 20.5"H
ES76 (Triple Station)	23.5"D x 76"W x 20.5"H

Model # will change based on features added

How to Order ES-Series										
Infrared Operation	Manual Bypass to add Knee Operated Water with IR Operation	Knee Operated Soap with IR Operation	Foot Operated Water	Foot Operated Soap	Digital Scrub Timer	Eye Wash	Thermostatic Mixing Valve (add on to Eye Wash option)	Laminar Flow	220/240V	Pedestal Base
IR	MB	KSP	FOW	FSP	TM	EYE	TV	LF	220	PB

Example 1: Base Model # ES25 with Infrared Operation, Manual Bypass to add Knee Operated Water & Soap, Digital Scrub Timers, and Pedestal Base = Model # **ES25-IR-MB-TM-PB**

Example 1: Base Model # ES47 with Laminar Flow = Model # **ES47-LF**

SS-Series

Surgical Scrub Sinks

The SS-Series is our premier line of surgical scrub sinks. These sinks combine the best material, components, and craftsmanship available on the market today. Choose from single, dual, or triple stations.



SS32
Single Station



SS64
Dual Station

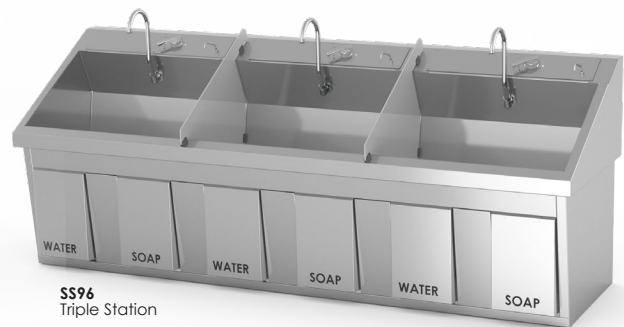

SS96
Triple Station

STANDARD FEATURES

- Single, dual, or triple stations
- Deep sloping basin
- Adjustable thermostatic controlled pressure regulating mixing valve (one per station)
- Knee operated water & soap (optional with IR sinks)
- Check stop strainers for ease of maintenance
- High mount swivel gooseneck spout with adjustable swivel spray aerator
- Flow control valve
- Backflow preventers
- Infrared sinks are equipped with a 24 volt plug in transformer
- Splash screen dividers with dual and triple station sinks
- Main support and Z-brackets (wall support optional)
- 304 stainless steel polished and ground to a #4 finish

OPTIONAL FEATURES

- Infrared operation
- Infrared soap dispenser
- Manual bypass to add knee operated water & soap with IR operation
- Knee operated soap with IR water operation
- Foot operated water
- Foot operated soap
- Digital scrub timer
- Eye wash
- Thermostatic mixing valve (add on to eye wash option)
- Laminar flow
- 220/240V power supply
- Pedestal base
- In-wall chair carrier
- Wall shelf over sink
- Lighted wall shelf over sink

SS-Series Standard Models	
Base Model #	Overall Dimensions
SS32 (Single Station)	27.5"D x 32"W x 37"H
SS64 (Dual Station)	27.5"D x 64"W x 37"H
SS96 (Triple Station)	27.5"D x 96"W x 37"H

Model # will change based on features added

Recommended Optional Products			
Base Model #	In-Wall Chair Carrier #	Shelf Over Sink #	Lighted Shelf Over Sink #
SS32	S0001	SH0001 (12"D x 32" W)	SH0001-L
SS64	S0002	SH0002 (12"D x 64" W)	SH0002-L
SS96	S0003	SH0003 (12"D x 96" W)	SH0003-L

SS-Series Features & Options



SS96
Triple Station (shown with multiple optional features)

How to Order SS-Series

Infrared Operation	Infrared Soap Dispenser	Manual Bypass to add Knee Operated Water and Soap with IR Operation	Knee Operated Water with IR Operation	Knee Operated Soap with IR Operation	Foot Operated Water	Foot Operated Soap	Digital Scrub Timer	Eye Wash	Thermostatic Mixing Valve (add on to Eye Wash option)	Laminar Flow	220/240V	Pedestal Base
IR	IRD	MB	KOW	KSP	FOW	FSP	TM	EYE	TV	LF	220	PB

Example 1: Base Model # SS32 with Infrared Soap Dispenser, Digital Scrub Timer, and Pedestal Base = Model # **SS32-IRD-TM-PB**

Example 2: Base Model # SS96 with Foot Operated Water, Eye Wash, and Laminar Flow = Model # **SS96-FOW-EYE-LF**

Utility Requirements

Utility	Connection On Unit	Pressure Range	Temperature	Consumption
Drain	1 1/2" x 6" Tail Piece	N/A	N/A	N/A
Cold Water	1/2" NPT	20-50 PSIG	70° F. Max	2 GPM Per Station
Hot Water	1/2" NPT	20-50 PSIG	180° F. Max	2 GPM Per Station
Electrical (IR Units Only)	120V	N/A	N/A	N/A

Optional
Infrared Soap Dispenser



Only available for the SS-Series Surgical Scrub Sinks

Ergonomically Friendly

Processing Sinks

NEW FEATURES

- 12" Angled Backsplash
- Backsplash Mounted Faucets
- 30" Deep Standard Sink Top
- 20" Deep Standard Basin
- 2 1/2" Front of Sink to Basin
- Individual Plumbing for Adjustable Height Sinks
- Universal Workflow
- Larger Seismic Brackets
- Optional Pegboard Backframe and Accessories
- Optional Bolt-on Side Splash
- Optional H-Brace with Lower Shelf

STANDARD FEATURES

- Open pipe base
- Single, dual, or triple basins
- Fully welded construction with reinforced tops
- 37" standard height for stationary sinks
- Adjustable feet
- Marine edge
- Flat working surface
- Etched gallon markings
- Basin size: 24"W x 20"L x 10"D

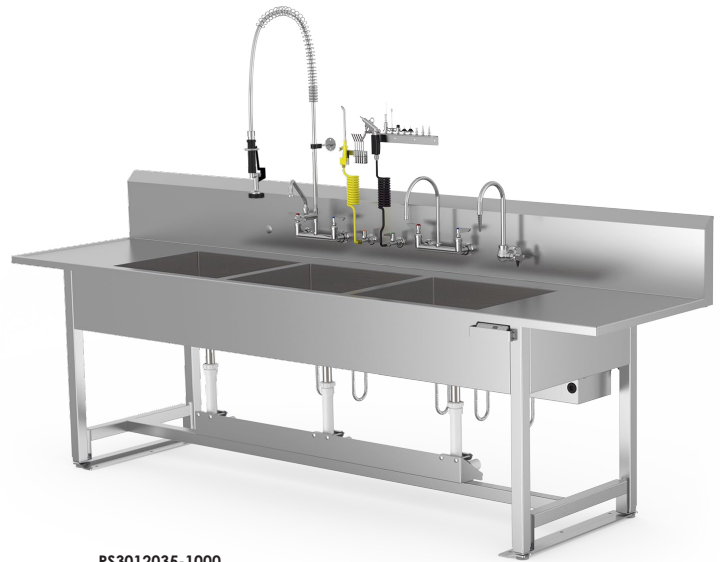

PS3012035-1000

(shown with electronic adjustable height pipe base with universal workflow and optional pre-rinse faucet, mixing valve faucet, DI water faucet, air gun, and water gun)



Note: ETL compliance for adjustable height models only.

Stationary Height Standard Models

Base Model #	Overall Dimensions
PS307237-1000	30"D x 72"W x 37"H, Single Basin
PS309637-1000	30"D x 96"W x 37"H, Dual Basin
PS3012037-1000	30"D x 120"W x 37"H, Triple Basin

Model # will change based on features added

Electronic Adjustable Height Standard Models

Base Model #	Overall Dimensions
PS307235-1000	30"D x 72"W x 35"H, Single Basin
PS309635-1000	30"D x 96"W x 35"H, Dual Basin
PS3012035-1000	30"D x 120"W x 35"H, Triple Basin

Power Requirements (Electronic Adjustable Height Sinks)

120 Volt, 60 Hz, single phase, 15 amp GFCI protected electrical outlet, installed per local building codes, and provides protective earth

Model # will change based on features added

Processing Sink Options

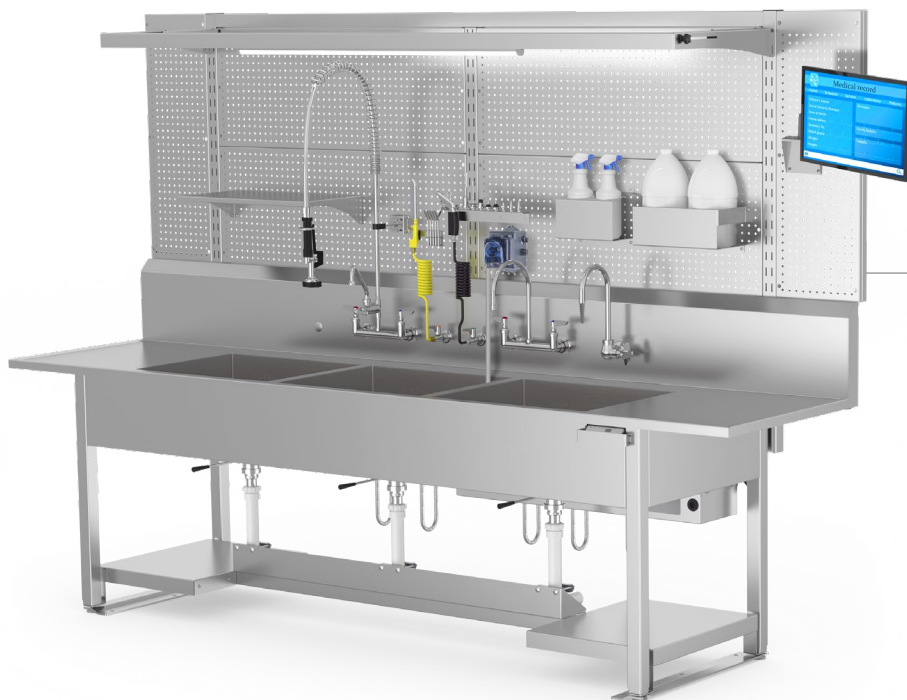

Backframe w/ optional accessories

PS3012035-1000

(shown with electronic adjustable height base with universal workflow and optional pre-rinse faucet, gooseneck faucet, DI water faucet, air gun, water gun, spray bottle holder, gallon jug holder, adjustable shelf, dosing pump and overhead LED light)

OPTIONAL FEATURES

- **Ergonomically friendly** electronic adjustable height with four position programming
 - Electronic adjustable height range: 32.5"–39.5"
- Mixing valve faucet
- Pre-rinse faucet
- Deionized (DI) water faucet
- Air gun kit (with 5 tips)
- Water gun kit (with 8 tips)
- Eye wash
- Larger basin: 30"W x 20"L x 10"D
- Hand lever drains
- Copper drain system (not compatible with deionized water)
- Lower shelf (left and/or right)
- Optional pegboard backframe
- Optional pegboard backframe accessories:
 - Overhead LED light
 - Bin rail (3" and 5" optional plastic bins available)
 - Monitor mount
 - Gallon jug holder
 - Spray bottle holder
 - Glove dispenser
 - Dosing System
 - Overhead shelf

Stainless Steel Casework & Cabinets

MAC Medical's full line of stainless steel Wall Cabinets, Base Cabinets, High Cabinets, Operating Room Cabinets, Mobile Cabinets, Nurses Documentation Stations, and Scope Cabinets can be configured in a number of ways to create the arrangement your facility needs.

Whether you need a complete renovation or a new construction, we can work with your elevation plans and facility planners to meet any specific need. As with all our products, all stainless steel cabinets are built with quality and durability in mind.



From Concept To Completion

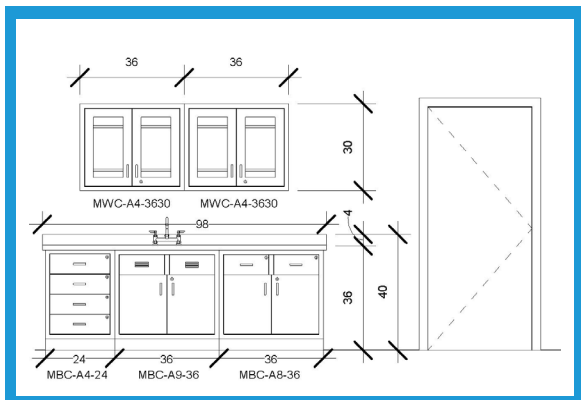

1 Plan

MAC Medical's experienced team of engineers can help conceptualize and plan a solution for your casework needs. Whether those needs are simply one cabinet or a complex build-out, we pride ourselves on helping you find a solution that works best for your facility. We will start with a proof of concept, and will revise your drawings until they meet your requirements.

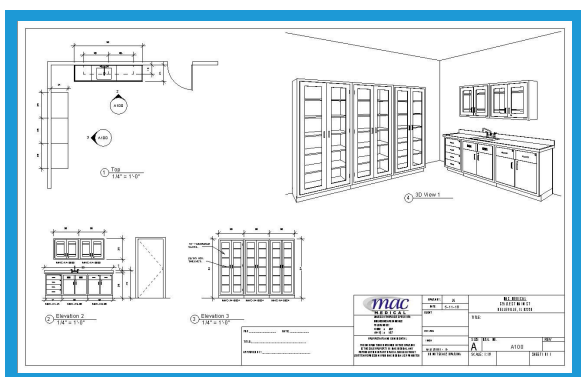

2 Build

Once the engineering drawings have been finalized and approved, your casework project starts to come to life in our 122,500 square foot manufacturing facility. After your project has been built, MAC Medical makes sure your product passes our rigorous quality and standards check list prior to shipment. Quality built and American made continues to be our competitive advantage.



3 Install

When your casework arrives at its destination, MAC Medical makes sure installation happens smoothly and timely. We communicate with the contractors/installers to ensure your product is installed according to your specifications. In short, MAC Medical stays involved from concept to completion.

Contact Us

Contact our customer service department toll free at **877-828-9975**, or by email at sales@macmedical.com.





**Wall
Cabinets**

Magnetic door catches
with a quiet close!



**High
Cabinets**



**Base
Cabinets**

STANDARD FEATURES

- Magnetic door catches with a quiet close
- Seamless front face on all cabinets
- Revit® files & spec sheets available
- Fully welded construction
- Type 300 series stainless steel
- Stainless steel shelves (where applicable, shelves adjust in 1 ½" increments)
- 4" standard pull handle (excludes sliding doors)
- ¾" tempered glass (where applicable)
- Adjustable feet on Base Cabinets & High Cabinets

*See our casework catalog for model #'s, dimensions,
and optional features or visit the casework section
on our website at www.macmedical.com*



Operating Room Cabinets

MAC Medical's full line of stainless steel Operating Room Cabinets can be assembled and configured in a number of ways to create a bank of cabinets to fit your facility needs. Standard models are recessed with several optional features to choose from.

STANDARD FEATURES

- Magnetic door catches with a quiet close
- Seamless front face on all cabinets
- Revit® files & spec sheets available
- Recessed
- Fully welded construction
- Type 300 series stainless steel
- Stainless steel shelves (excludes Table Accessory Cabinets & Desk Cabinets, shelves adjust in 1 ½" increments)
- ⅜" tempered glass (where applicable)

Casework Accessories

Wall Shelves



See Page 60

STANDARD FEATURES

- Type 300 series stainless steel
- 1" lip on back
- Pre-punched for easy wall mounting (mounting hardware not included)

Corner Guards



Sloping Tops



STANDARD FEATURES

- Type 300 series stainless steel
- 25° slope angle

Counter Tops

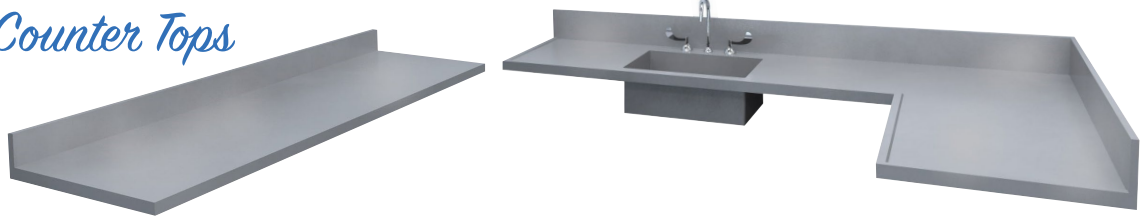

Counter tops are fabricated from type 300 series stainless steel. The underside is reinforced with channels, sink included. Marine edges are provided for counter tops containing sinks. Sinks are fabricated (not drawn) from type 300 series stainless steel with a 5/16" cove corner, laser etched gallon markings, positive pitch towards drain, and are integrally welded to top. A 4" backsplash is standard with optional side splashes. Please consult MAC Medical for custom sizes meeting any and all architectural requirements. Counter tops are fabricated in one piece where design and materials permit.

All counter tops are sold separately and installed by others along with any plumbing fixtures

Operating Room Bases - 12" High

STANDARD FEATURES

- Type 300 series stainless steel

Mobile Cabinets

STANDARD FEATURES

- Fully welded construction
- Glass hinged doors
- Stainless steel adjustable shelves
- Standard 4" pull handle
- 4" casters (2 swivel & 2 locking)
- Pull out drawers
- Flat top

OPTIONAL FEATURES

- Sloping top
- No doors
- Push handles
- Non-marring bumper
- Cam lock
- Tee handles
- Tee handles with key lock
- Electronic keypad door lock
- Pegboard back



Shown with optional sloping top

Contact Us

Contact our customer service department toll free at **877-828-9975**, or by email at **sales@macmedical.com**.

INSPIRED
TO BE BETTER

Nurses Documentation Stations



NDS908430

STANDARD FEATURES

- Free standing
- Fully welded construction
- Configuration includes wall cabinet, base cabinet, and tower cabinet (tower cabinet can be configured on either side)
- Magnetic door catches
- Stainless steel adjustable shelves
- Standard handles
- Integrated wire management system
- Full CAD renderings
- Engineered room layouts in CAD based on customer provided drawings
- Multiple layouts for individual requirements
- Swivel desk with (2) 5" swivel casters

OPTIONAL FEATURES

- Stainless steel doors
- Glass hinged doors
- Vented doors for electronics
- No doors
- Pull out writing surface
- Pull out bottom shelf for easy PC install
- Heavy duty pull out drawers
- Key lock
- Tee handles
- Tee handles with key lock
- Electronic keypad door locks
- Pegboard back
- Sloping top (height varies on depth)
- Variable height bases

Standard Model

Base Model #	Overall Dimensions	Unit Configuration
NDS908430	30"D x 90"W x 84"H	Wall Cabinet (13"D x 48"W x 30"H) Base Cabinet (30"D x 24"W x 32.5"H) Tower Cabinet (30"D x 42"W x 84"H) Counter Top (30"D x 48"W x 36"H) Swivel Desk (22"D x 42"W x 34"H)

Additional shelving available for purchase, shelving adjusts in 1 1/2" increments

Model # will change based on features added

Scope Cabinets

STANDARD FEATURES

- Fully welded construction
- Glass hinged doors with louvered vents
- Scope hangers
- Lower rack to keep scopes aligned
- Removable drain pan
- Padded back wall to prevent damage

OPTIONAL FEATURES

- Power vent (includes ventilation fan, digital timer switch, and HEPA filter)
- Sloping top (25°)



MSCA44224-301

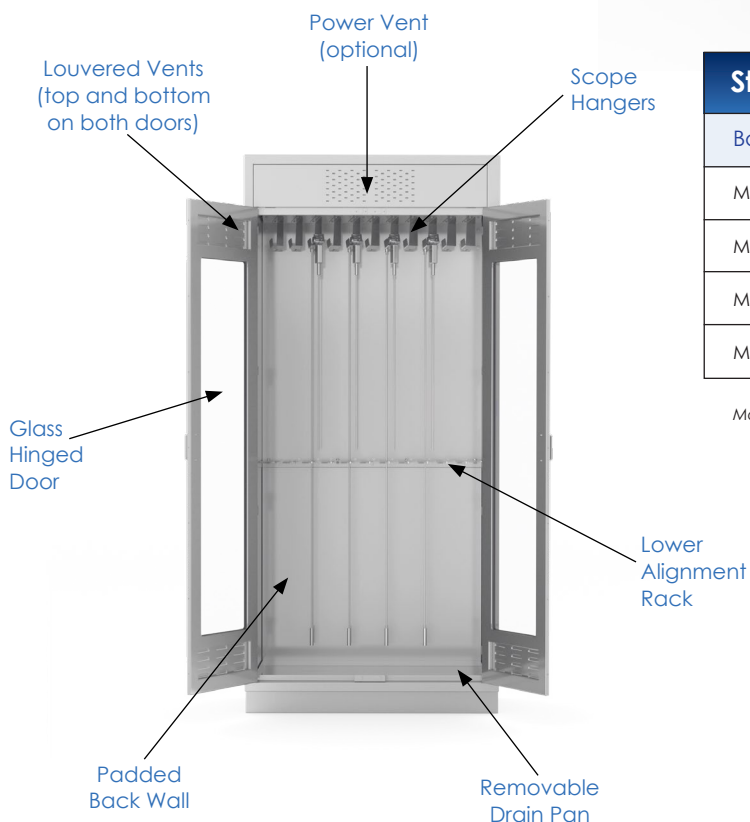

Standard Models		
Base Model #	Overall Dimensions	# of Scope Hangers
MSC-A2-3618	18" D x 36" W x 92" H	9
MSC-A2-4218	18" D x 42" W x 92" H	11
MSC-A2-3624	24" D x 36" W x 92" H	18
MSC-A2-4224	24" D x 42" W x 92" H	22

Model # will change based on features added

Plastic Laminate Casework

MAC Medical, Inc. is proud to offer U.S.A.-made plastic laminate wall cabinets, base cabinets, and high cabinets, in popular configurations for maximum convenience and workflow optimization.

Plastic laminate casework is offered in three laminate types: Thermally Fused Laminate (TFL), High Pressure Laminate (HPL), and Vinyl Foil (3DL). Choose one of six typical groupings (shown on page 33). Further customize your casework grouping by choosing a cabinet and countertop finish. Your casework comes complete with postform non-drip countertop, 4" satin finish wire pulls, self closing drawer slides, cabinet shelves, sink (if applicable), and more.



Thermally Fused (TFL) Laminate



High Pressure (HPL) Laminate



Vinyl Foil (3DL) Laminate



Other door/drawer combinations and cabinet sizes are available upon request.

Thermally Fused Laminate (TFL) STANDARD FEATURES

- Modular Thermal Fused Laminate (TFL) with dowel and glue construction
- Postform non-drip countertop, sink and faucet included
- 4" satin finish wire pulls included
- Self-closing drawer slides and 3-way 110° Euro hinges
- Neutral white TFL interiors
- All cabinets have (1-2) adjustable shelves based on size (except sink units)

TFL CABINET COLORS

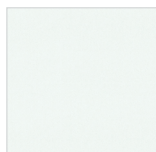

White



Fog Grey

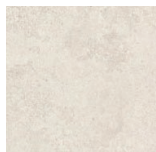

Luna Winter

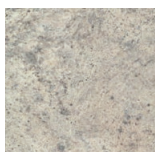

Madura Pearl

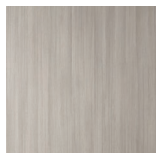

Gregio Pine

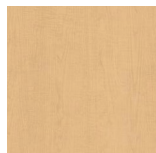

Fusion Maple

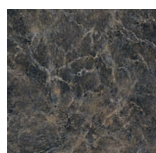

Ebony Fusion

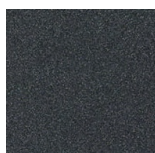

Graphite Nebula

COUNTERTOP COLORS



Group A shown

Additional colors are available upon request.
All colors subject to availability.

High Pressure Laminate (HPL) STANDARD FEATURES

- High Pressure Laminate (HPL) with dowel and glue construction
- Postform non-drip countertop, sink and faucet included
- 4" satin finish wire pulls included
- Self-closing drawer slides and 3-way 110° Euro hinges
- Neutral white TFL interiors
- All cabinets have (1-2) adjustable shelves based on size (except sink units)

HPL CABINET COLORS



Field Elm

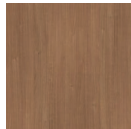

River Cherry



Ribbon Marble



Backyard Patio

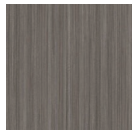

Portico Teak

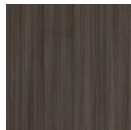

Skyline Walnut



Bronze Legacy



Graphite Nebula

STANDARD LAMINATE COUNTERTOP COLORS

(UPGRADE) SOLID SURFACE COUNTERTOP COLORS



Pearl Mirage



Cashmere Melange



Zen Grey

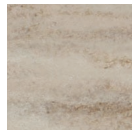

Iron Falls (Premium)



Group D shown

Additional colors are available upon request.
All colors subject to availability.

Vinyl Foil Laminate (3DL) STANDARD FEATURES

- Modular Vinyl Foil (3DL) Shaker Style door with dowel and glue construction
- Postform non-drip countertop, sink and faucet included
- 4" satin finish wire pulls included
- Self-closing drawer slides and 3-way 110° Euro hinges
- Neutral white TFL interiors
- All cabinets have (1-2) adjustable shelves based on size (except sink units)

STANDARD (3DL) CABINET COLORS



Winter

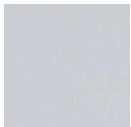

Fashion Grey



Candlelight

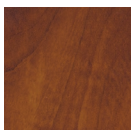

Summerflame

STANDARD COUNTERTOP COLORS



Kalahari Topaz

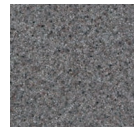

Mystique Night

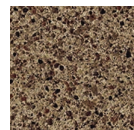

Henna Vesta



Smoky Topaz

(UPGRADE) SOLID SURFACE COUNTERTOP COLORS

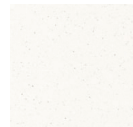

Frosty White

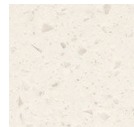

Yukon Riverstone



Zen Grey

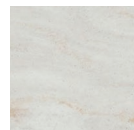

Beige Travertine (Premium)

DOOR STYLES



Classic



Elegante

Additional colors are available upon request.
All colors subject to availability.

TYPICAL GROUPINGS

Refer to customer service for further clarification on dimensions.

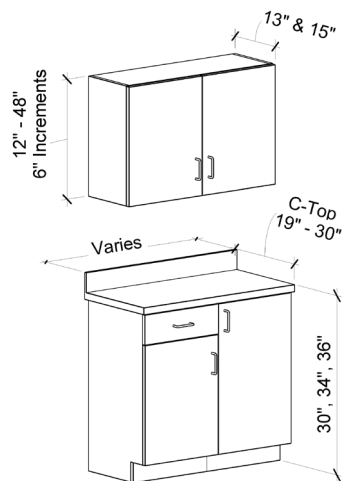

GROUP A

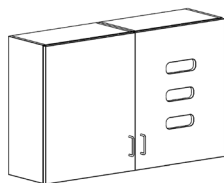

GROUP B

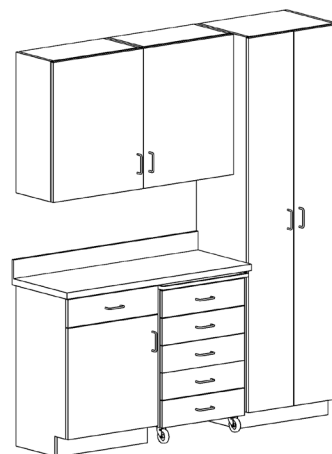

GROUP C

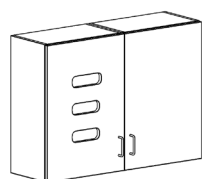

GROUP D

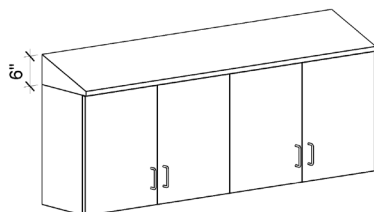

GROUP E

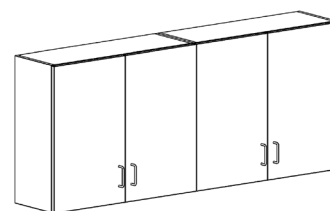

GROUP F

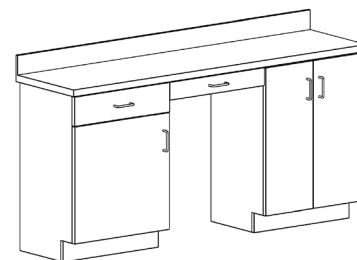
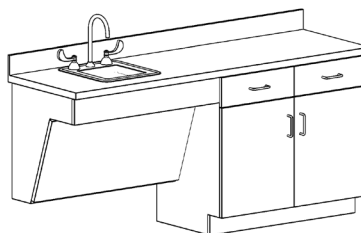
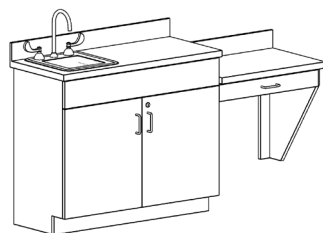

Note: If single door cabinet, you must specify door hinge "R" (Right) or "L" (Left). Other door/drawer combinations and cabinet sizes are available upon request.

Contact Us

Contact our customer service department toll free at **877-828-9975**, or by email at **sales@macmedical.com**.



Stainless Steel Carts

MAC Medical, Inc. manufactures a full line of stainless steel carts that feature fully welded construction for strength and durability. Choose from standard designs or have our engineering department custom design any specific case cart to satisfy your facility needs.



Closed Case Carts

STANDARD FEATURES

- Fully welded construction with inner skeletal system for strength and our easy service bolt-on features
- Soundproof tops and doors for quiet operation
- 6" maintenance-free, high temp, high pressure stainless steel casters with sealed ball bearings (3 swivel & 1 fixed directional)
- Bolt-on exterior push handle for better control
- Bolt-on full wrap-around non-marring bumper assembly
- Bolt-on door hinges
- Bolt-on positive lock door latches
- Bolt-on 8.5" x 11" card holder
- Bolt-on tamper evidence security hasps



OPTIONAL FEATURES

- Glass door(s)
- Etching for serial tag ID/tracking
- Etching for end user logo
- Adjustable solid shelf (non roll out)
- Adjustable solid shelf (roll out)
- Adjustable perforated shelf (non roll out)
- Adjustable perforated shelf (roll out)
- Adjustable wire shelf (non roll out)
- Adjustable wire shelf (roll out)
- Side extensions
- Flag system (one each of red, yellow and green)
- Clean/dirty indicator (slide or wheel)
- Total locking casters
- Tow hitch



Standard Models			
Base Model #	Case Dimensions	Overall Dimensions	Doors
MMCCB3	25"D x 40.25"W x 32"H	26.875"D x 45.75"W x 39.625"H	2
MMCCB4	25"D x 40.25"W x 47"H	26.875"D x 45.75"W x 54.625"H	2
MMCCB6	25"D x 23.625"W x 32"H	26.875"D x 29.125"W x 39.625"H	1
MMCCB9	25"D x 23.625"W x 47"H	26.875"D x 29.125"W x 54.625"H	1
MMCCB12	25"D x 36"W x 32"H	26.875"D x 41.5"W x 39.625"H	2
MMCCB14	25.875"D x 46.5"W x 32"H	27.75"D x 52"W x 39.625"H	2

Model # will change based on features added

Open Case Carts

MMOCC16
(shown with 3 optional adjustable perforated shelves)



MMOCC19
(shown with an optional adjustable solid shelf)



MMOCC21
(shown with 2 optional adjustable perforated shelves)

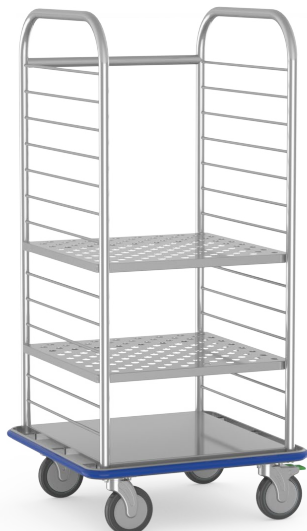

STANDARD FEATURES

- Open design
- Sturdy built cart – perfect for storage, supplies, linens, or distribution
- Full wrap around non-marring bumper
- Stainless steel guard rail
- 6" composite casters* (2 swivel & 2 locking)

* Not cart-washable

OPTIONAL FEATURES

- Adjustable solid shelf (non roll out)
- Adjustable perforated shelf (non roll out)
- Adjustable wire shelf (non roll out)
- Fixed shelving
- Wire grid on back side
- 6" maintenance-free, high-temperature, high-pressure stainless steel casters with sealed ball bearings (3 swivel & 1 directional lock)
- Total locking casters
- 6" plastic bin
- 10" plastic bin

Standard Models

Base Model #	Overall Dimensions
MMOCC13	29.375"D x 40.375"W x 37.5"H
MMOCC16	26.125"D x 60.375"W x 67"H
MMOCC18	27"D x 40.75"W x 37"H
MMOCC19	30.875"D x 40.75"W x 39"H
MMOCC21	29.75"D x 29.75"W x 62"H
MMOCC24	24"D x 30"W x 54"H
MMOCC25	24"D x 24"W x 54"H

Shelves ordered separately

Model # will change based on features added

Some values are rounded up to the next 1/8" for simplicity

Ergonomically Friendly

Vertical Handle Case Carts

STANDARD FEATURES

- **Ergonomically friendly** vertical handles for precise control
- Fully welded construction
- 8.5" x 11" card holder
- Sound-proofed tops and doors for quiet operation
- Adjustable perforated roll out stainless steel shelves
- Full wrap around non-marring bumper
- Tamper evidence security tabs
- Positive lock door latches
- 6" maintenance-free, high-temperature, high-pressure stainless steel casters with sealed ball bearings (3 swivel & 1 directional lock)

OPTIONAL FEATURES

- Glass door
- Etching for serial tag ID/tracking
- Etching for end user logo
- Adjustable solid shelf (roll out)
- Adjustable solid shelf (non roll out)
- Adjustable perforated shelf (non roll out)
- Adjustable perforated shelf (roll out)
- Adjustable wire shelf (roll out)
- Adjustable wire shelf (non roll out)
- Side extensions
- Flag system (one each of red, yellow, and green)
- Improved clean/dirty indicator (slide or wheel)
- Tow hitch
- Total locking casters
- Silicon door gaskets for complete sterility control
- Cool touch handles



Optional
Cool Touch Handles

Available for any of our Vertical Handle Case Carts (or any 1" diameter vertical handle)

Retrofit kit includes two Cool Touch Handles and corresponding hardware (Part # WC011-100-KT)



Optional
Clean/Dirty Indicator

Available for any new or pre-existing Vertical Handle Case Cart (Part # CC0230-01-BIO)



Standard Models		
Base Model #	Case Dimensions	Overall Dimensions
MMCV95	26.5"D x 39.5"W x 40.75"H	27.75"D x 48.25"W x 53"H
MMCV107	24.75"D x 40"W x 38.75"H	26"D x 48.75"W x 51"H

Model # will change based on features added

Sealed Case Carts



STANDARD FEATURES

- Fully welded construction
- Sound-proofed tops and doors for quiet operation
- Exterior push handle for better control
- Door gaskets for increased dust control
- Locking rods to keep doors secure
- Full wrap around non-marring heavy-duty bumper
- Magnetic door catches to keep doors open while in use
- 8.5" x 11" card holder
- Tamper evidence security tabs
- 6" maintenance-free, high-temperature, high-pressure stainless steel casters with sealed ball bearings (2 rigid & 2 swivel with brake)

OPTIONAL FEATURES

- Etching for serial tag ID/tracking
- Etching for end user logo
- Adjustable solid shelf (non roll out)
- Adjustable solid shelf (roll out)
- Adjustable perforated shelf (non roll out)
- Adjustable perforated shelf (roll out)
- Adjustable wire shelf (non roll out)
- Adjustable wire shelf (roll out)
- Side extensions
- Flag system (one each of red, yellow and green)
- Clean/dirty indicator (slide or wheel)
- Total locking casters
- Tow hitch

Standard Models			
Base Model #	Case Dimensions	Overall Dimensions	Doors
MMSCCB3	25.5" D x 41.25" W x 32" H	27.375" D x 46.75" W x 39.5" H	2
MMSCCB4	25.5" D x 41.25" W x 47" H	27.375" D x 46.75" W x 54.5" H	2
MMSCCB6	25.5" D x 24.625" W x 32" H	27.375" D x 30.125" W x 39.5" H	1
MMSCCB9	25.5" D x 24.625" W x 47" H	27.375" D x 30.125" W x 54.5" H	1
MMSCCB12	25.5" D x 37" W x 32" H	27.375" D x 42.5" W x 39.5" H	2
MMSCCB14	26.375" D x 47.5" W x 32" H	28.25" D x 53" W x 39.5" H	2

Model # will change based on features added

Utility Carts



UC *Light Duty*

STANDARD FEATURES

- Fully welded stainless steel construction
- 3-sided 1" lip (on top & middle shelf) to keep items from rolling off
- Front side turned down (on top & middle shelf) for easier access
- Open design for easy cleaning & sanitizing
- 4" swivel casters (non-locking)
- Push handle
- 200 lb. weight capacity

OPTIONAL FEATURES

- Locking casters
- Additional shelves
- Customized shelf size & spacing



AL-200 *Medium Duty*

STANDARD FEATURES

- Fully welded stainless steel construction
- 3-sided 1" lip (on top & middle shelf) to keep items from rolling off
- Front side turned down (on top & middle shelf) for easier access
- Open design for easy cleaning & sanitizing
- 6" swivel casters (non-locking)
- Push handle
- 300 lb. weight capacity

OPTIONAL FEATURES

- Locking casters
- Additional shelves
- Customized shelf size & spacing

Standard Models

Base Model #	Overall Dimensions
UC162432	16"D x 24"W x 32"H
UC162834	16"D x 28"W x 34"H
UC224034	22"D x 40"W x 34"H
AL-200 (A-Frame Design)	19"D x 38.5"W x 35.5"H
AL-200-2442 (A-Frame Design)	24"D x 42"W x 35.5"H

Model # will change based on features added

Sterilizer Carts

STANDARD FEATURES

- 304 stainless steel welded construction
- Three (3) adjustable shelves
- Perforated bottom
- Electropolished surface
- 6" high-temperature, high pressure casters
- Teflon non-marring bumper

OPTIONAL FEATURES

- Additional shelves



Standard Model	
Base Model #	Overall Dimensions
MMSSC243657	24"D x 36"W x 57"H

Model # will change based on features added

Sterile Wrap Carts

STANDARD FEATURES

- Stainless steel welded construction
- Solid bottom shelf for additional storage
- Four (4) adjustable bars
(adjustable in 1" increments for comfortable work height)
- 3" casters (2 swivel & 2 locking)

Standard Model	
Base Model #	Overall Dimensions
MMSC203863	20"D x 38"W x 63"H

Model # will change based on features added



MMSC202863

Contact Us

Contact our customer service department toll free at **877-828-9975**, or by email at **sales@macmedical.com**.





Laminate & Stainless Steel Mobile Medical Carts

MAC Medical's full line of laminate mobile medical carts can be configured in a number of ways to create the arrangement your facility needs. Several optional features are available also. As with all our products, our laminate mobile medical carts are built with quality and durability in mind.

STANDARD FEATURES

- 1 1/4" Base with full wrap around non-marring bumper
- Storage panels for organizing trays and baskets diagonally or horizontally
- 4" composite casters (2 swivel & 2 locking)
- Magnetic catches on solid and glass doors
- Vinyl anti-roll tops on short models
- Sturdy built cart – perfect for storage, supplies, linens, or distribution

OPTIONAL FEATURES

- Locks (cam locks or digital e-locks)
- Stainless steel shelf with slide-out hanging racks
- Solid surface tops on short laminate mobile carts
- Total locking casters

MOBILE CART MATERIALS

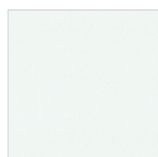

White TFL Laminate

Durable thermal-fused white laminate is on 3/4" thick high-density engineered wood



Gray TFL Laminate

Durable thermal-fused gray laminate is on 3/4" thick high-density engineered wood



Aluminum HP Laminate

Brushed aluminum high-pressure laminate is a cost effective way to get the appearance of stainless steel at a lower price

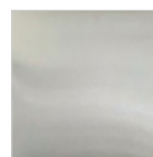

Stainless Steel

Fully welded corrosion resistant, hygienic, maintenance free, heavy duty type 304 stainless steel

MOBILE CART MODELS

Short Mobile Carts



MMLCSW245836

Picture above is a wide gray laminate cart with bow handles, standard top, a 5th wheel for stability, and optional tambour doors & cam locks



MMLCSM314036

Picture above is a medium width gray laminate cart with standard top, wire pulls, and optional glass doors & storage bins



MMLCSN312436

Picture above is a narrow white laminate cart with a standard solid door & top, and wire pull

Short Models (36" Tall)		
Base Model #	Overall Dimensions	Cabinet Dimensions
MMLCSW245836	23 3/4"D x 57 7/8"W x 36"H	18 5/8"D x 53 7/8"W x 29 7/8"H
MMLCSM314036	31 1/8"D x 40 1/2"W x 36"H	26 1/2"D x 36 1/2"W x 29 7/8"H
MMLCSN312436	31 1/8"D x 23 3/8"W x 36"H	26 1/2"D x 18"W x 29 7/8"H

Tall Models (78" Tall)		
Base Model #	Overall Dimensions	Cabinet Dimensions
MMLCTW245878	23 3/4"D x 57 7/8"W x 78"H	18 5/8"D x 53 7/8"W x 71 7/8"H
MMLCTM314078	31 1/8"D x 40 1/2"W x 78"H	26 1/2"D x 36 1/2"W x 71 7/8"H
MMLCTN312478	31 1/8"D x 23 3/8"W x 78"H	26 1/2"D x 18"W x 71 7/8"H

Tall Mobile Carts



MMLCTW245878

Picture above is a wide gray laminate cart with tambour doors, bow handles, cam locks, and a 5th wheel for stability



MMLCTM314078

Picture above is a medium width stainless steel cart with glass doors, flat handles, and a digital e-lock



MMLCTN312478

Picture above is a narrow aluminum laminate cart with tambour door, bow handle, and a cam lock

MOBILE CART DOOR STYLES



Solid

Solid doors provide the best security. They are strong and more tamper resistant.



Glass

Glass doors give you the accessibility of seeing what is in your cart without opening the doors.



Tambour

Tambour doors slide open and save space as the doors roll up. You don't have to allow for the doors to swing open.

Door Accessories

Door Pulls



Wire Pull



Flat Pull



Bow Pull

Locks



Cam Lock



Digital E-Lock

Not available with Tambour doors.

Magnetic Catches



Glass and solid doors come with magnetic catches.

MOBILE CART INTERIOR ACCESSORIES

ABS Trays & Baskets

40x60 Clear ISO Models



5cm TRAY - MMT054060
SHORT DIVIDER - MMDO540
LONG DIVIDER - MMDO560



10cm TRAY - MMT104060
SHORT DIVIDER - MMD1040
LONG DIVIDER - MMD1060



20cm TRAY - MMT204060
SHORT DIVIDER - MMD2040
LONG DIVIDER - MMD2060



10cm TRAY - MMT104060ND
(NOT DIVIDABLE)
* LID - L4060



10cm BASKET - MMB104060
SHORT DIVIDER - MMD1040
LONG DIVIDER - MMD1060



20cm BASKET - MMB204060
SHORT DIVIDER - MMD2040
LONG DIVIDER - MMD2060

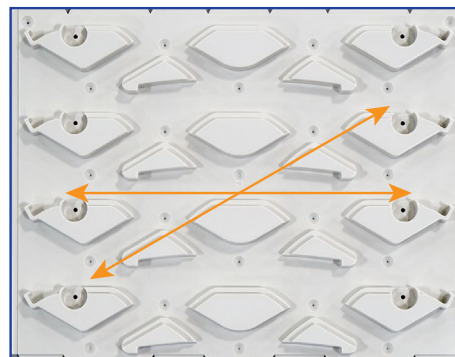

Trays and Baskets can be stored both diagonally and horizontally.

Stainless Steel Tables

MAC Medical, Inc. manufactures a full line of stainless steel tables including Instrument Tables, Utility Tables, Nested Tables, Work Tables, Space Saver Tables, Adjustable Over Operating Tables, Central Supply Tables, and Prep & Pack Workstations.



Instrument Tables

STANDARD FEATURES

- Fully welded construction
- Reinforced tops for tables over 25" wide
- Stainless steel legs (1 1/4")
- Stainless steel top (type 300 series)
- Stainless steel under shelf (type 300 series)
- 3" swivel casters

OPTIONAL FEATURES

- Locking casters
- Guard rails on 3 sides (available on top or bottom shelf)
- Guard rails on all 4 sides (available on top or bottom shelf)
- H or U brace instead of under shelf
- 1" lip on back
- Multiple under shelves

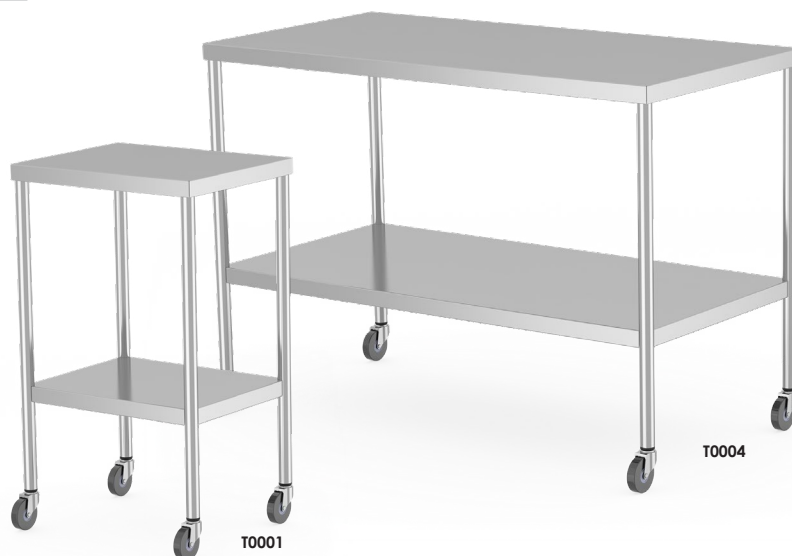

Standard Models	
Base Model #	Overall Dimensions
T0001 <i>Best Seller!</i>	16"D x 20"W x 34"H
T0002	16"D x 30"W x 34"H
T0003	24"D x 36"W x 34"H
T0004 <i>Best Seller!</i>	24"D x 48"W x 34"H
T0005	24"D x 60"W x 34"H
T0006	24"D x 72"W x 34"H

Model # will change based on features added

Utility Tables

STANDARD FEATURES

- Fully welded construction
- 1 under shelf
- Drawer(s)
- Top guard rail (on 3 sides)
- 3" casters (2 swivel & 2 locking)

OPTIONAL FEATURES

- Multiple under shelves for one drawer tables
- No guard rail



Standard Models

Base Model #	Overall Dimensions	Drawers
T0086 <i>Best Seller!</i>	16"D x 20"W x 34"H	1
T0077	16"D x 20"W x 34"H	2

Model # will change based on features added

Nested Tables



STANDARD FEATURES

- Fully welded construction
- Stainless steel legs (1 1/4")
- Stainless steel tops (type 300 series)
- Stainless steel U brace (1 1/4")
- 2" swivel casters

Standard Models

Model #	Overall Dimensions
T0089	Set of 6 (T0090 through T0095)
T0090	24"D x 48"W x 42"H
T0091	22"D x 44"W x 40"H
T0092	20"D x 40"W x 38"H
T0093	18"D x 36"W x 36"H
T0094	16"D x 32"W x 34"H
T0095	14"D x 28"W x 32"H

Model # will change based on features added

Ergonomically Friendly

Work Tables



STANDARD FEATURES

- Fully welded construction
- Reinforced stainless steel top (type 300 series)
- Stainless steel under shelf (type 300 series)
- 2" square legs
- Added supports
- 5" casters (2 swivel & 2 locking)

OPTIONAL FEATURES

- **Ergonomically friendly** adjustable heights (manual or electronic)
 - Manual adjustable height range: 36"–55"
 - Electronic adjustable height range: 36"–43"
- H or U brace instead of under shelf
- Full base unit underneath
- Drawers under all sizes
- Stainless steel guard rails
- Multiple under shelves
- Adjustable feet

Standard Models

Base Model #	Overall Dimensions
WT0003	24"D x 36"W x 34"H
WT0004	24"D x 48"W x 34"H
WT0005	24"D x 60"W x 34"H
WT0054	30"D x 72"W x 34"H
WT0055	36"D x 72"W x 34"H
WT0059	30"D x 60"W x 34"H

Model # will change based on features added

Ergonomically Friendly

Space Saver Tables



STANDARD FEATURES

- Fold down top shelf with lip (space saving feature!)
- One under shelf
- 2" square legs
- 4" casters (2 swivel & 2 locking)

OPTIONAL FEATURES

- **Ergonomically friendly** adjustable heights (manual or electronic)
 - Manual adjustable height range: 36"–55"
 - Electronic adjustable height range: 36"–54"

Standard Models

Base Model #	Overall Dimensions
TSPS-1000-6030	30"D x 60"W x 36"H
TSPS-1000-7230	30"D x 72"W x 36"H

Model # will change based on features added

Ergonomically Friendly

Adjustable Over Operating Tables

STANDARD FEATURES

- **Ergonomically friendly** manual adjustable height
 - Manual adjustable height range: 36.5"–48.25"
- 3" casters (2 swivel & 2 locking)

OPTIONAL FEATURES

- 1" lip on back



T0082-3442

Standard Models	
Base Model #	Overall Dimensions (height at lowest setting)
T0082-3442	42"D x 34"W x 36.5"H
T0082-4824	24"D x 48"W x 36.5"H
T0082-6024	24"D x 60"W x 36.5"H

Model # will change based on features added

Central Supply Tables

STANDARD FEATURES

- Heavy duty, stainless steel construction
- Sterile frame
- 2" square legs
- One under shelf
- 5" casters (2 swivel & 2 locking)

OPTIONAL FEATURES

- 6" plastic bin
- 10" plastic bin
- Drawer



CST2472-SWF

Standard Models	
Base Model #	Overall Dimensions
CST3260-SWF	32"D x 60"W x 34"H
CST2472-SWF	24"D x 72"W x 34"H
CST3684-SWF	36"D x 84"W x 34"H

Model # will change based on features added

Ergonomically Friendly

Prep & Pack Workstations

Designed with ergonomics in mind, the Prep & Pack Workstations feature a modular design, allowing for multiple configurations and adjustability for all body types. Choose from the many optional features including adjustable height (manual or electronic), overhead light, articulating magnification light, CPU holder, electrical strip, and more.

STANDARD FEATURES

- 100% stainless steel construction
- Modular design allows for multiple configurations
- Integrated footrest
- 5" casters (2 swivel & 2 locking)

OPTIONAL FEATURES

- **Ergonomically friendly** adjustable heights (manual or electronic)
 - Adjustable height range: 34"–46"
- Bin rail
- Overhead light
- Articulating magnification light
- Electrical strip
- CPU holder
- Pull out keyboard tray
- Magnetic dry erase board
- Adjustable flat shelf for riser frame
- Adjustable 45° angled shelf for riser frame
- Lower shelf
- Spool holder
- Drawer boxes (single or double)
- Pegboard panel



TWS-3672-EAH-B
(shown with multiple optional features)

Standard Models

Base Model #	Overall Dimensions (height at lowest setting)
TWS-3060-B	32"D x 60"W x 84"H
TWS-3072-B	32"D x 72"W x 84"H
TWS-3660-B	38"D x 60"W x 84"H
TWS-3672-B	38"D x 72"W x 84"H

Model # will change based on features added

Contact Us

Contact our customer service department toll free at **877-828-9975**, or by email at sales@macmedical.com.



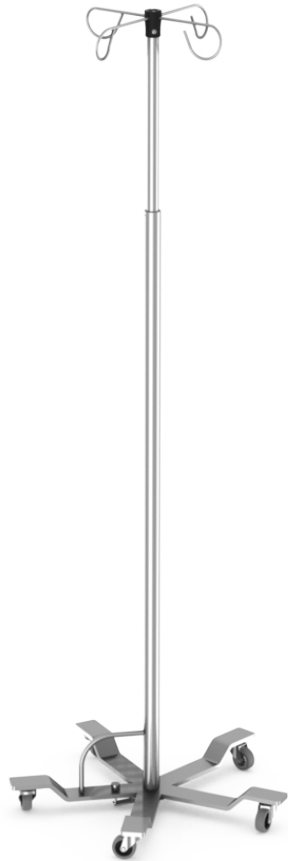

Stainless Steel Stands

MAC Medical, Inc. manufactures a full line of stainless steel stands including Mayo Stands, IV Stands, and Solution Stands.

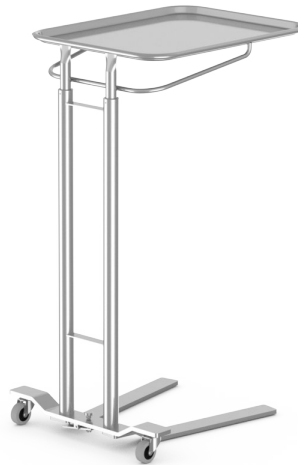

Mayo Stands

STANDARD FEATURES

- Full welded stainless steel construction
- Height adjustment range: 36"–58"
- 2" swivel casters

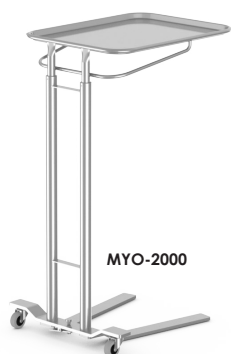

MYO-2000 *Best Seller!*

- Removable 21 1/4" x 16 1/4" stainless steel tray
- Foot operated friction lock height adjustment/dual post

MYO-2001

- Same as MYO-2000 except 19 1/8" x 12 5/8" stainless steel tray

MYO-2002

- Same as MYO-2000 except 25" x 20" stainless steel tray



MYO-4000

- Removable 21 1/4" x 16 1/4" stainless steel tray
- Manual knob operated adjustment/single post

MYO-4001

- Same as MYO-4000 except 19 1/8" x 12 5/8" stainless steel tray



IV Stands

STANDARD FEATURES

- Stainless steel construction
- Height adjustment range: 68"-108"
- Tip resistant base
- 2" swivel casters

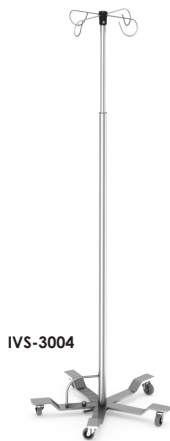

IVS-3000 Series

- Foot operated
- 5-leg stand
- Welded base

IVS-3004

- Four hook design

IVS-3006

- Six hook design



IVS-5000 Series

- Hand operated
- 4-leg stand
- Knock down version (assembly required)

IVS-5004

- Four hook design

IVS-5006

- Six hook design

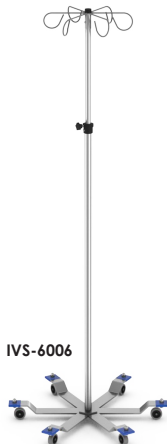

IVS-6000 Series

- Hand operated
- 6-leg stand
- Knock down version (assembly required)

IVS-6004

- Four hook design

IVS-6006

- Six hook design



IVS-7000 Series

- Hand operated
- 5-leg stand
- Knock down version (assembly required)

IVS-7004 *Best Seller!*

- Four hook design

IVS-7006

- Six hook design

Solution Stands

STANDARD FEATURES

- Fully welded stainless steel construction
- Single and double basin designs available
- Available with lower shelf
- Open frame design allows accessibility from any side
- 2" swivel casters



SOL-1000

SOL-1000

- Overall Dimensions: 14"D x 14"W x 34"H
- Removable 7 quart stainless steel basin



SOL-1001

SOL-1001 *Best Seller!*

- Same as SOL-1000 except with stainless steel lower shelf
- Removable 7 quart stainless steel basin



SOL-2000

SOL-2000

- Overall Dimensions: 16"D x 27.5"W x 34"H
- Two removable 7 quart stainless steel basins



SOL-2001

SOL-2001

- Same as SOL-2000 except with stainless steel lower shelf
- Two removable 7 quart stainless steel basin

Contact Us

Contact our customer service department toll free at **877-828-9975**, or by email at sales@macmedical.com.



Other Stainless Steel Products

MAC Medical, Inc. manufactures several other stainless steel products including Linen Hampers, Gowning Benches, Step Stools, Kick Buckets, Pass Through Windows, Stationary Wall Shelves, Fold Down Wall Shelves, and Peg Boards.

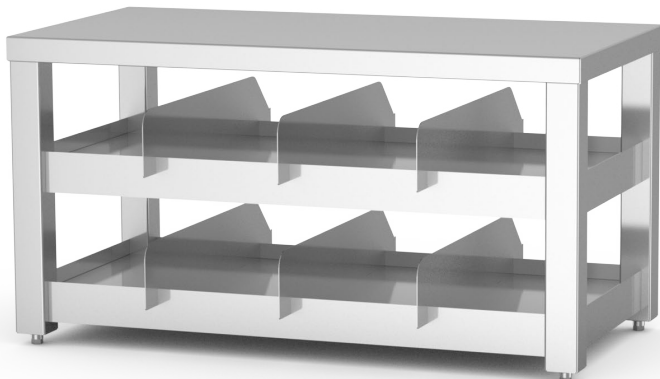
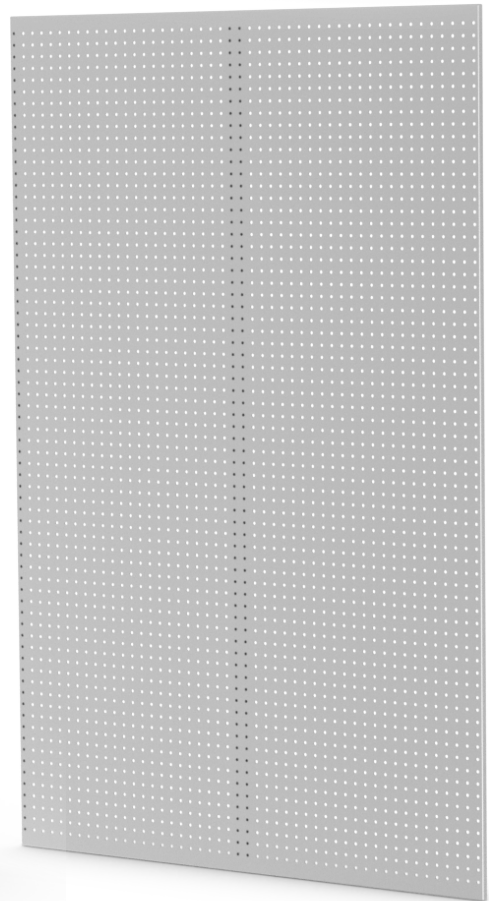

Linen Hampers

STANDARD FEATURES

- Fully welded, heavy gauge all stainless steel construction
- Heavy gauge platform to support bags and ease of removal
- 2" swivel casters

OPTIONAL FEATURES

- Foot operated stainless steel lid
- Rotating bumper guards over casters



LH-1000

- Overall dimensions: 35"H x 57 1/4" perimeter
- Accommodates 18" diameter bags



LH-1001

- Overall dimensions: 35"H x 78 5/8" perimeter
- Accommodates 25" diameter bags

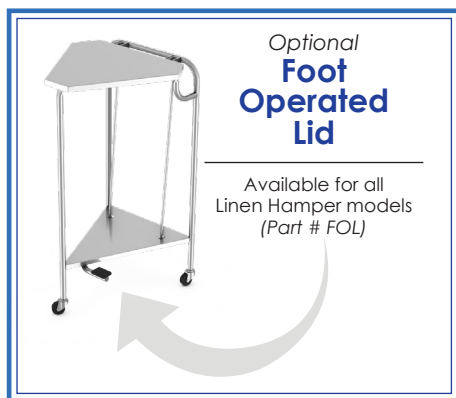

Gowning Benches

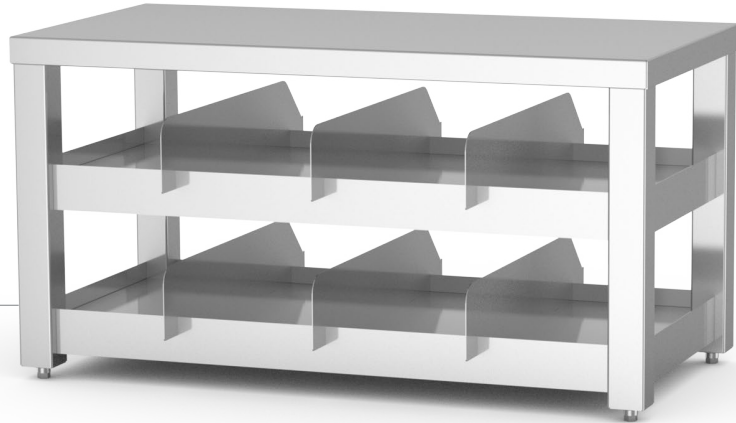

STANDARD FEATURES

- Stainless steel construction
- H-Brace
- Adjustable feet

OPTIONAL FEATURES

- Casters
- Dividers
- Middle & bottom shelf

Standard Models

Base Model #	Overall Dimensions
GB183619-2SH-AF	18"D x 36"W x 19"H
GB184819-2SH-AF	18"D x 48"W x 19"H

Model # will change based on features added

Step Stools



STANDARD FEATURES

- Heavy duty, stainless steel construction
- Tip resistant
- Corrugated, black rubber top surface on each stool
- Rubber floor tips
- Single step stools (STS121805) are stackable and connect together to create a large platform

OPTIONAL FEATURES

- Easy roll around transport cart with 4 swiveling casters (2 locking) available for STS121805 – holds up to 5 single step stools

Optional Transport Cart

Available for STS121805
(Part # T0800)

Holds up to 5 single step stools



Standard Models

Model #	Overall Dimensions
STS121805 (single step) Best Seller!	12"D x 18"W x 6.25"H
STS121808-HD (single step with handle)	12"D x 18"W x 6.25"H (41" H at handle)
STS263015 (two steps)	26"D x 30"W x 15"H

Kick Buckets

STANDARD FEATURES

- Stainless steel frame
- Perimeter bumper to protect walls
- Tip resistant
- 2" swivel casters



KB-1000 *Best Seller!*

- Overall dimensions: 14"H x 13 1/2" diameter
- Removable 13 quart stainless steel basin



KB-2000

- Overall dimensions: 8"H x 16 1/4" diameter
- Removable 9 1/2 quart stainless steel basin

Pass Through Windows

STANDARD FEATURES

- 3/16" tempered glass
- Adjustable width for wall thickness (between 4.5"-6.125")
- 4-sided gasket
- Dual swing hinge with adjustable spring tension

OPTIONAL FEATURES

- Decontamination side shelf (various sizes)
- Clean side shelf (various sizes)



Standard Models	
Base Model #	Outside Dimensions
PTW0001	37.5"W x 34.5"H (no shelf)
PTW0002	37.5"W x 34.5"H (shelf included)
PTW0003	24"W x 34.5"H (no shelf)

Model # will change based on features added

Stationary Wall Shelves

STANDARD FEATURES

- Stainless steel construction
- Pre-drilled for easy wall mounting (mounting hardware not included)

OPTIONAL FEATURES

- Bullnose front

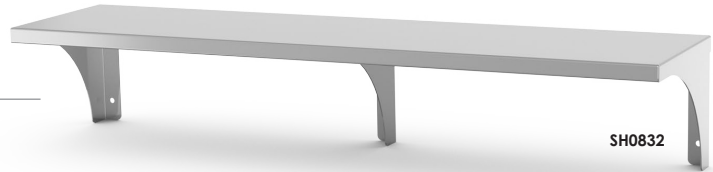

Standard Models		
Model #	Overall Dimensions	Brackets
SH0624	6"D x 24"W	2
SH0630	6"D x 30"W	2
SH0824	8"D x 24"W	2
SH0830	8"D x 30"W	2
SH0832	8"D x 32"W	3
SH0836	8"D x 36"W	3
SH1224	12"D x 24"W	2
SH1236	12"D x 36"W	3
SH1248	12"D x 48"W	3
SH1260	12"D x 60"W	4

Fold Down Wall Shelves

STANDARD FEATURES

- Stainless steel construction
- Fold down shelf
- Marine edge
- Pre-drilled for easy wall mounting (mounting hardware not included)

OPTIONAL FEATURES

- Bullnose front

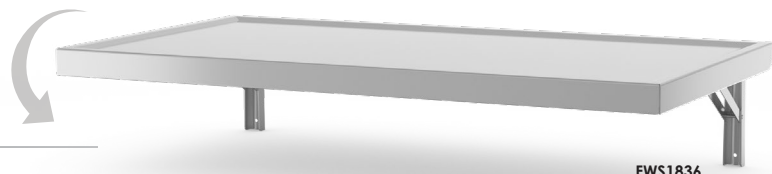

Standard Models		
Model #	Overall Dimensions	Brackets
FWS1224	12"D x 24"W	2
FWS1236	12"D x 36"W	2
FWS1248	12"D x 48"W	2
FWS1824	18"D x 24"W	2
FWS1836	18"D x 36"W	2
FWS1848	18"D x 48"W	2

Peg Boards

STANDARD FEATURES

- Stainless steel construction (3/4" overall thickness from wall)
- 9/32" diameter holes on 1" center
- Key hole slots for mounting (mounting hardware not included)
- Can be mounted vertically or horizontally

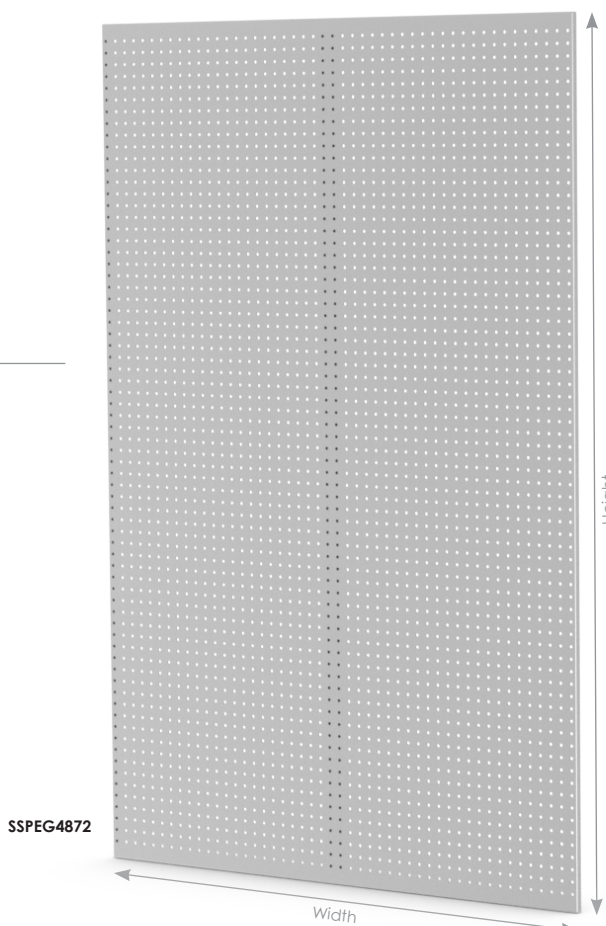

Standard Models	
Model #	Overall Dimensions
SSPEG2436	24"W x 36"H
SSPEG3636	36"W x 36"H
SSPEG3648	36"W x 48"H
SSPEG4248	42"W x 48"H
SSPEG4848	48"W x 48"H
SSPEG4872	48"W x 72"H
SSPEG4896	48"W x 96"H

Standard Hooks	
Model #	Hook Size
IC0128-01	3-3/32" stainless steel single peg board hook (fits 3/16" & 1/4" diameter holes)
IC0128-02	5-3/16" stainless steel single peg board hook (fits 3/16" & 1/4" diameter holes)
IC0128-03	8-3/4" stainless steel single peg board hook (fits 3/16" & 1/4" diameter holes)
IC0901	8" stainless steel single peg board hook (fits 1/4" diameter holes)
IC0128-05	9" stainless steel single peg board hook (fits 1/4" diameter holes)

All hooks are compatible with all peg board models and are sold separately



QUICK SHIP Program

Rapid response for urgent projects

MAC Medical's Quick Ship Program offers stocked inventory of select products to meet your urgent project needs. With fast and reliable 1-2 day shipments, this program provides the flexibility of quick orders for your time sensitive projects.



Item #	Item Description	Qty.
KB-1000	Kick Bucket, 13 Quart	1-15
LH-1000	Linen Hamper, Triangular, 18" Bag	1-5
LH-1001	Linen Hamper, Triangular, 25" Bag	1-5
MYO-2000	Mayo Stand, Dual Post, Foot Lock Release, Removable 21.25" x 16.25" Tray	1-10
MYO-2002	Mayo Stand, Dual Post, Foot Lock Release, Removable 25" x 20" Tray	1-5
SOL-1001	Solution Stand, 14"D x 14"W x 34"H, 7 Quart Single Basin, Lower Shelf	1-5
SOL-2001	Solution Stand, 16"D x 30"W x 34"H, 7 Quart Double Basin, Lower Shelf	1-5
IVS-6004	IV Stand, Hand Operated, 4 Hooks, 6-Leg Stand, Knock Down Version	1-3
IVS-7004	IV Stand, Hand Operated, 4 Hooks, 5-Leg Stand, Knock Down Version	1-3
STS121805	Step Stool, 12"D x 18"W x 6.25"H, Single Step	1-10
T0001	Instrument Table, 16"D x 20"W x 34"H	1-10
T0002	Instrument Table, 16"D x 30"W x 34"H	1-5
T0003	Instrument Table, 24"D x 36"W x 34"H	1-5
T0004	Instrument Table, 24"D x 48"W x 34"H	1-5
T0005	Instrument Table, 24"D x 60"W x 34"H	1-10
T0086	Utility Table, 16"D x 20"W x 34"H, 1 Drawer	1-5
MS1824	Warming Cabinet Mobile Stand, 20"D x 28"W x 34"H	1-5
MS2430	Warming Cabinet Mobile Stand, 26"D x 34"W x 34"H	1-10
SWC182424-G-NB	D-Series Warming Cabinet, Single Chamber, Glass Door, No Base, 20.5"D x 24"W x 24.5"H	1-2
SWC243024-G-NB	D-Series Warming Cabinet, Single Chamber, Glass Door, No Base, 26.5"D x 30"W x 24.5"H	1-2
SWC243036-G-2B	D-Series Warming Cabinet, Single Chamber, Glass Door, 2" Base, 26.5"D x 30"W x 36"H	1-2
DWC243074T-4B	D-Series Warming Cabinet, Dual Chamber, Stainless Steel Doors, 4" Base, Chambers in Thirds, 26.5"D x 30"W x 74.5"H	1-2
DWC243074T-G-4B	D-Series Warming Cabinet, Dual Chamber, Glass Doors, 4" Base, Chambers in Thirds, 26.5"D x 30"W x 74.5"H	1-2



Rapid
response
for urgent
projects

** Quick Ship eligible items are available for urgent requests only and must be specified when ordering.*



Company-wide Green Initiative

MAC Medical is committed to making sound decisions to manage our environmental footprint and protect the environment. Our company-wide green initiative is conscious of our impact on the planet and underscores our commitment to sustainability.



Recycled Material

MAC Medical purchases nearly 1.7 million lbs. of recycled steel each year. Carbon emissions are reduced by 70% when using recycled steel versus newly mined steel. This equates our usage of recycled steel to an approximate 1,884 metric ton reduction in carbon emissions. It is estimated that planting 5 trees reduces 1 metric ton of CO₂. Thus, our usage of recycled steel versus newly mined steel equates to us planting 9,444 trees last year.

Additionally, our corrugated packaging products have a recycled content of 36%. This is comprised of 30% post-consumer fiber (recycled boxes) and 6% pre-consumer fiber (waste created at the mills that is recycled).



Facility Lighting

MAC Medical's manufacturing facility has been outfitted with skylights and energy efficient LED lights. Skylights help reduce the amount of electricity needed to illuminate the working space, while LED lights provide a longer operational life span and an overall reduction in wattage used. In fact, 24,298 watts are saved in our entire facility for every hour LED lights are in use. This reduction in wattage reduces carbon emissions and equates to us planting approximately 150 trees per year.



Manufacturing Practices

MAC Medical practices lean manufacturing to aid in the manufacturing process. Our lean techniques enable us to deliver high quality products at lower costs and ultimately minimizing our impact on the planet. One of those techniques is our investment in fiber laser cutting technology which allows for the maximization of each stainless steel sheet used in production. Even though 100% of our scrap steel is recycled, our fiber laser cutters largely reduce the amount of scrap sent to the smelter.



Warranty Information

Limited Lifetime Warranty

MAC Medical warrants to the original purchaser that its Proprietary Products will be free from defects in workmanship or materials under normal use and service for the life of the product, so long as owned by the original purchaser, according to the limitations set forth below. Defective products shall be repaired or replaced at MAC Medical's option at no cost to the original purchaser provided:

1. The customer must obtain a written return authorization supplied by MAC Medical's customer service department. The product must be returned, properly packaged, with a copy of the original sales receipt and copy of the RMA authorization. Please call (877) 828-9975 or (618) 476-3550 to receive a return authorization.
2. The customer must pre-pay freight charges to and from MAC Medical and must ship merchandise properly packaged, in a way the product will not be damaged during transit to the factory. MAC Medical does not warranty any freight damage to or from the factory. It is the customer's responsibility to inspect the product for packaging damage before signing the BOL.

This warranty does not apply to products, which have been subject to abuse, misuse, accident, modification, alteration, tampering, negligence, lack of routine maintenance or misapplication; or products that have been repaired by other than MAC Medical or its authorized representatives.

This warranty does not apply to glass, fabrics, vinyl, seat coverings, cushions, padding or their stitching, gluing or installation. Component parts not manufactured by MAC Medical, such as casters, caster inserts, any components made from rubber or plastic, circuit boards, fan heaters, plumbing parts, electrical switches and other components are also excluded. For these component parts, MAC Medical will pass on the original manufacturer's warranty to MAC Medical equipment original purchasers. Please consult factory for questions regarding the warranties of these component parts. This warranty does not apply to custom fabricated products. Consult factory.

UNLESS EXPRESSLY SET FORTH IN THIS WARRANTY, THERE ARE NO OTHER WARRANTIES, WHETHER EXPRESS OR IMPLIED, OF FITNESS AND / OR MERCHANTABILITY OR ANY OTHER WARRANTY IMPLIED BY CUSTOM, USAGE OR COURSE OF DEALING.

Liability of MAC Medical under this warranty is limited to the repair and / or replacement of any products. MAC Medical specifically excludes and disclaims any responsibility for any incidental or consequential damages claimed to have arisen from any defect in workmanship or materials. No representative has any authority to change or enlarge the above warranty or MAC Medical liability. This supersedes all previous warranty provisions.

Contact Us

Corporate Office

200 Admiral Weinel Boulevard
Columbia, IL 62236

Manufacturing Plant

820 South Mulberry Street
Millstadt, IL 62260

Both facilities are located in Southern Illinois, making this an ideal place for centralized distribution to the entire United States.



For questions or to place an order, contact our customer service department:

Phone: 618-476-3550

Toll Free: 877-828-9975

Fax: 618-476-3337

Email: sales@macmedical.com

Website: www.macmedical.com

Thank You!

Our company has been in business for 20+ years and we could not have done it without people like you! We are grateful for your partnership and support. From humble beginnings to our current day manufacturing technology, serving the medical community has never been a task for MAC Medical, but more of a pleasure. As our company expands and continues to grow we will strive for excellence in our goal of serving you. Thank you for being a part of our story.



Sincerely,



Dennis Cooper
CEO/President

INSPIRED
TO
BE BETTER



MADE
IN THE **USA**



INSPIRED
TO BE BETTER

Customer needs are our first priority.

MAC Medical, Inc.
Publication No. CFU-01 Rev. E
February 2024

Corporate Office
200 Admiral Weinel Boulevard
Columbia, Illinois 62236

Manufacturing Plant
820 South Mulberry Street
Millstadt, Illinois 62260

Phone: 618-476-3550 • Toll Free: 877-828-9975 • Fax: 618-476-3337
Email: sales@macmedical.com • Website: www.macmedical.com

Information regarding products are subject to change without prior notice.