



# INSTRUCTION MANUAL



## PT1001 & PT1001-31 (General Transport Stretcher)



Read and understand all of the instructions and safety information in this manual before operating this product.

## DESCRIPTION OF PRODUCT

The General Transport Stretcher is capable of transporting 750 lb. It features directional movement, cornering and pivoting, Trendelenburg/reverse Trendelenburg bed positions, six IV pole configurations, ergonomically located oxygen tank holder, six brake/steer locations, Dual Fowler assisted adjustable back rest and large storage area for patient belongings.

The General Transport Stretcher comes as either a 29" bed width or a 31" bed width.

## PURPOSE OF THIS MANUAL

This manual provides the parts list, operation, cleaning and maintenance instructions for the General Transport Stretcher.

This manual pertains to both the PT1001 (29" bed width) and the PT1001-31 (31" bed width).

To place an order, contact our customer service department at **618-476-3550** or **877-828-9975** or by email at [sales@macmedical.com](mailto:sales@macmedical.com)



## Table of Contents

Warnings and Cautions Icon Key.....	3
Warnings and Cautions When Installing or Operating This Product.....	3
<b>General Material Specifications of the PT1001 and PT1001-31 General Transport Stretcher.....</b>	<b>4</b>
Overall Stretcher Dimensions.....	4
Parts List of PT1001 and PT1001-31 General Transport Stretcher.....	5
Operation of the PT1001 General Transport Stretcher.....	8
Fowler Adjustment for PT1001 and PT1001-31 General Transport Stretcher.....	13
Stretcher Optional Features.....	15
Maintenance.....	15
Cleaning.....	15
Transportation and Storage Conditions.....	16
Transportation Damage and Claims.....	16
Maintenance Record.....	17
Notes.....	18
Limited Lifetime Warranty.....	19

# *KEEP THIS MANUAL*

## Warnings and Cautions Icon Key

The following is a list identifying the various warning and caution icons used in this manual.

Icon Type	Icon	Description
Cautions		(Yellow triangle with an exclamation point) indicates the potential minor injury to personnel and damage to equipment.
		Note: The exclamation point will not be visible where only equipment damage is present.

## Warnings and Cautions When Installing or Operating This Product

1. Prior to installation or operation, the user must read the warnings and cautions listed below.
2. The following is a list of the safety precautions that must be observed when operating this equipment.



**WARNINGS** indicate the potential for danger to personnel.

**CAUTIONS** indicate the potential for damage to equipment.

These precautions are repeated (in whole or in part), where applicable, throughout the manual. It is important to review these precautions before using the equipment.



**WARNING - INJURY HAZARD -**

**REPAIRS AND ADJUSTMENTS** should be attempted only by experienced service agents fully acquainted with this equipment. The use of inexperienced, unqualified persons to service the equipment, or the installation of unauthorized parts, could cause serious personal injury, or result in costly damage.



**CAUTION - POSSIBLE EQUIPMENT DAMAGE -**

When cleaning the stretcher - see complete Cleaning Instructions in this manual.

**NOTE:** This product is to be used strictly for the purpose it was designed for. If this product is used in a manner not specified by MAC Medical, Inc., the protection provided by the equipment may be impaired. MAC Medical, Inc., disclaims all liability for the consequences of this product being used for purposes other than its intended design. Product modification or misuse can be dangerous. MAC Medical, Inc., disclaims all liability for the consequences of product alterations or modifications, as well as for the consequences which might result from the combination of this product with other products, whether supplied by MAC Medical, Inc., or by other manufacturers, unless such a combination has been specifically endorsed by MAC Medical, Inc.

## General Material Specifications of the PT1001 and PT1001-31 General Transport Stretcher

Chassis Shroud: LDR33/1 552 ABS FS8039	Mattress Pad: Polyurethane Foam Core
Wheel Lock Pedal: Hot Rolled Bar Stock	Pedals: Flexible PVC

### Overall Stretcher Dimensions

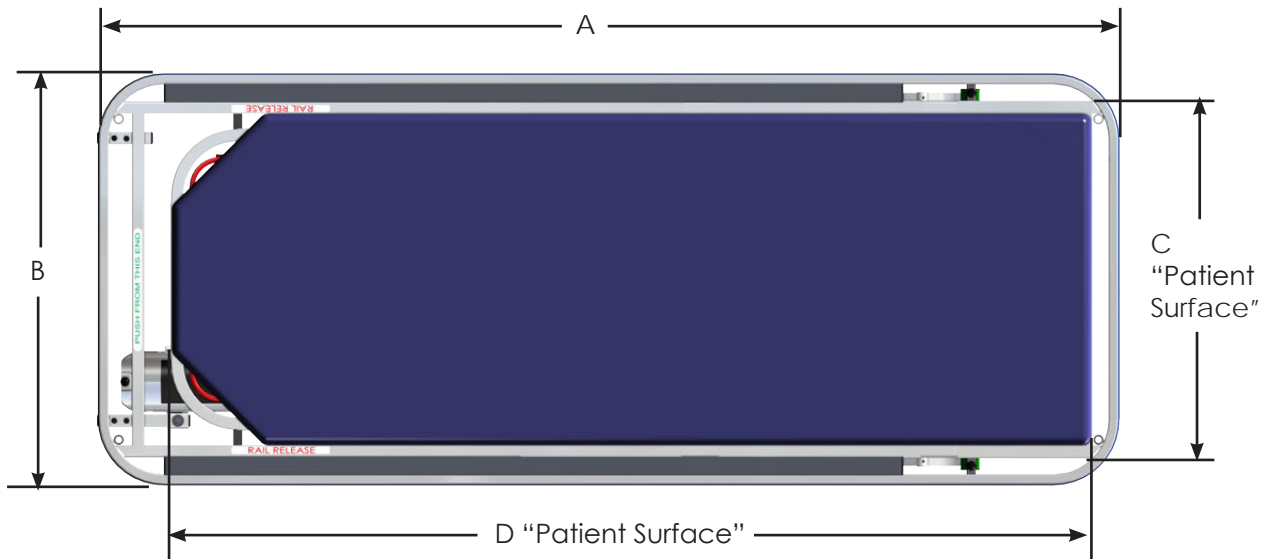
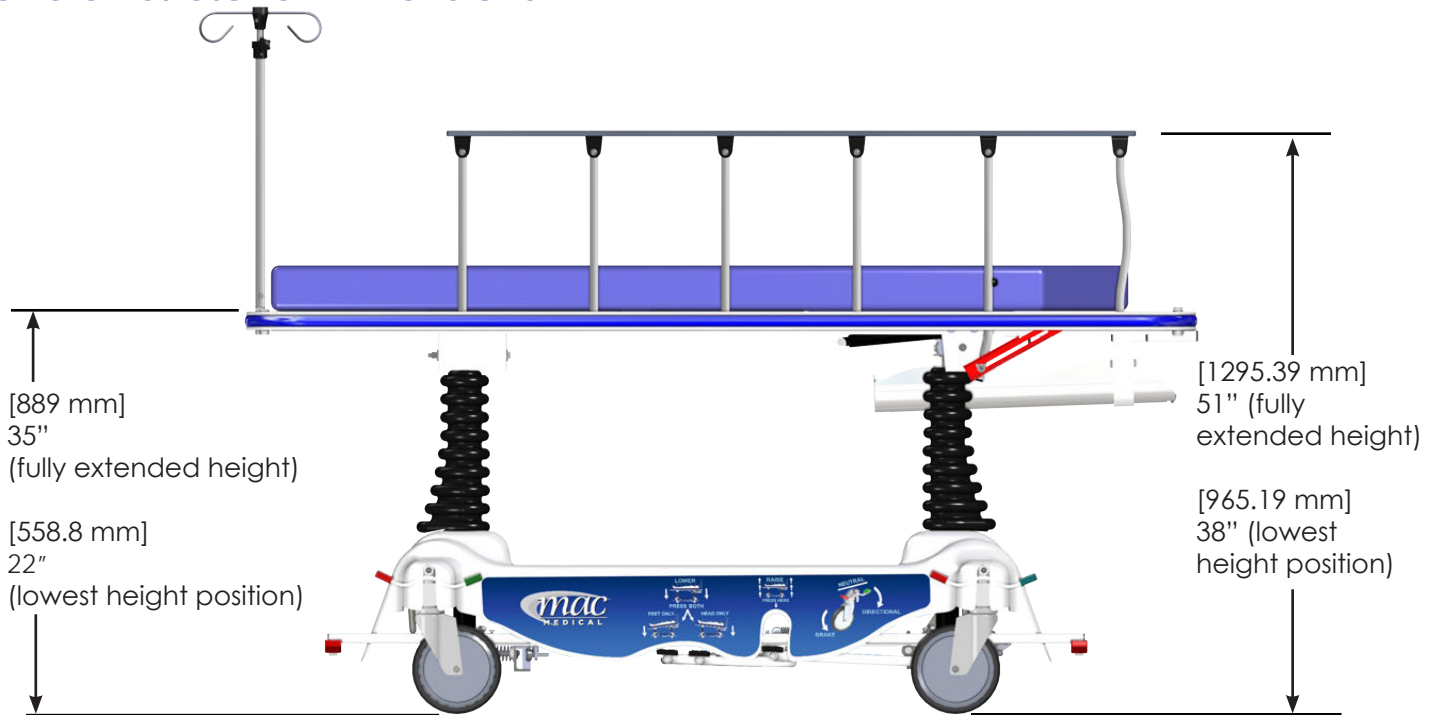

Width and Length Dimensions (in millimeters and inches)				
Model #	A	B	C	D
PT1001	[2116.14 mm] 83 5/16"	[852.49 mm] 33 9/16"	[739.77 mm] 29 1/8"	[1916.11 mm] 75 7/16"
PT1001-31	[2116.14 mm] 83 5/16"	[903.29 mm] 35 9/16"	[790.57 mm] 31 1/8"	[1916.11 mm] 75 7/16"

## Parts List of PT1001 and PT1001-31 General Transport Stretcher

The main structural and operational Stretcher components called out in the following illustrations are identified in the table on Page 7. The operational components will be covered in more detail in this installation manual.

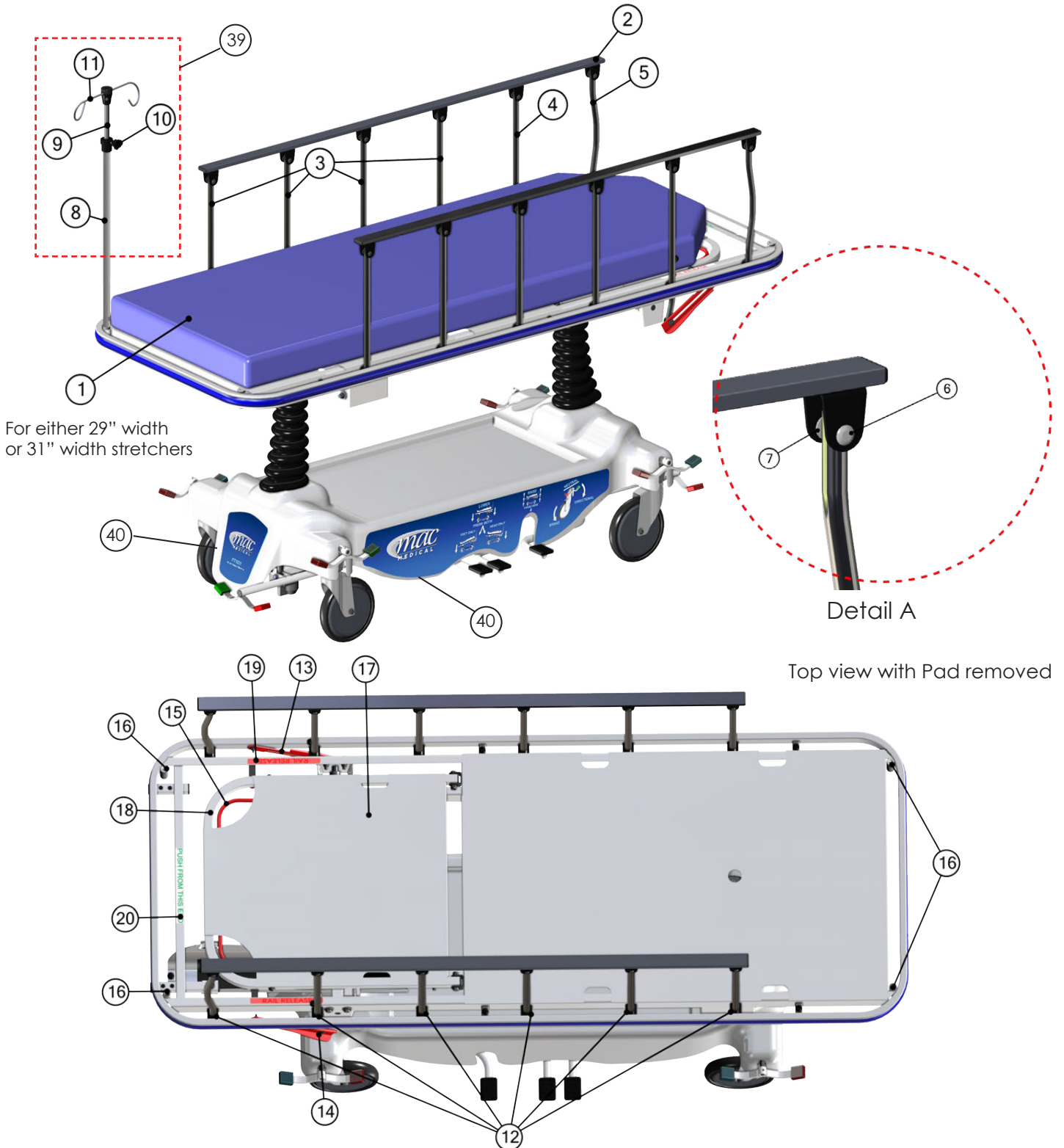

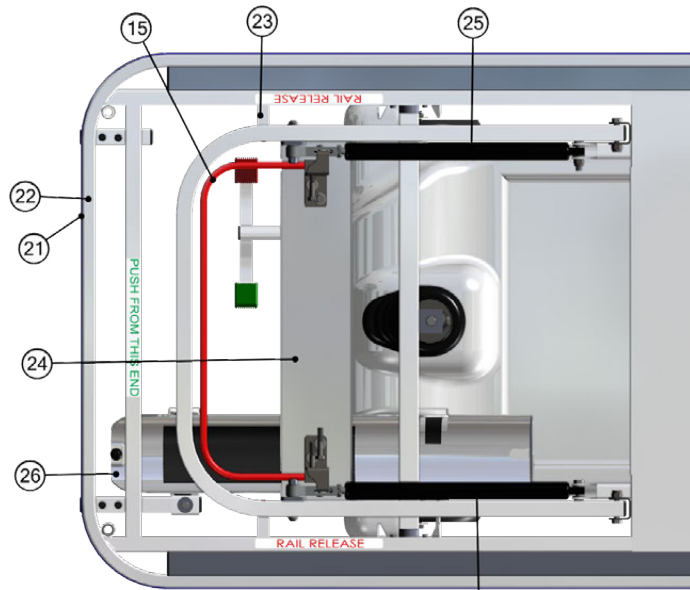

Top view of the stretcher bed with Pad and Back Rest removed for clarity

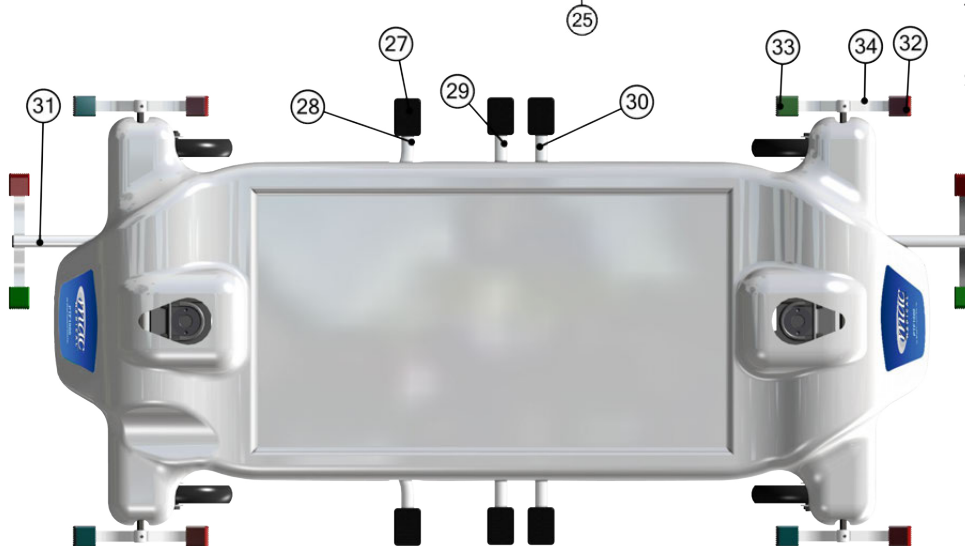

Top view of the bottom half of the stretcher

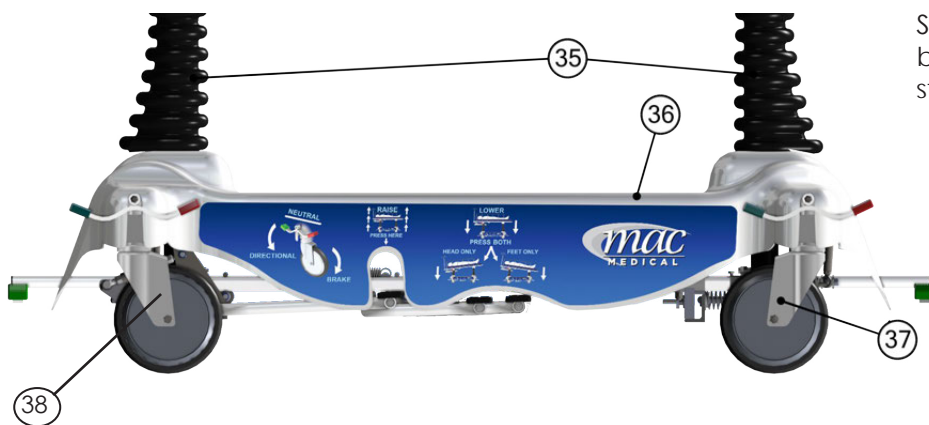

Side view of the bottom half of the stretcher



ID #	Part #	Description	Qty
1	ST0001-04	Pad, 29" Stretcher, 27" X 75" X 4"	1
1	ST0001-04-31	Pad, 31" Stretcher, 29" X 75" X 4"	1
2	STR0112-P	Rail Assembly	2
3	STR0064	Stretcher Arm, 16" Straight	8
4	STR0067	Stretcher Arm, 20.5" Locking	2
5	STR0066	Stretcher Arm, Head Of Bed (Arched)	2
6	H0028-01	Rivet, 2-piece compression	12
7	W0115-08	Washer	24
8	STR0075	Large Pole, IV Pole	1
9	STR0600-03	Tube, Small Pole IV	1
10	ST0098 NEW	Knob, Adjustment IV	1
11	STR0600-07	IV Hook Clamp Bottom, Small Pole IV	1
12	ST0029	Roller, Side Rail 12/Stretcher	12
13	SMST0004L-01	Rail Slide Latch (Left) (rail release)	1
14	SMST0004R-01	Rail Slide Latch (Right) (rail release)	1
15	STR0500-138	Release Handle	1
16	ST0026	Pole, IV Deli Socket	4
17	STR0502-04	Back Rest-Stretcher Bed	1
18	STR0500-137	Headrest Tube	1
19	ST0058-R	Decal, Stretcher "Rail Release"	2
20	ST0058-P	Decal, "Push From This End"	1
21	ST0025-02	Bumper, Blue	1
22	STR0500-132	Uni Strut 29" Stretcher Hoop	1
22	STR0500-132-31	Uni Strut 31" Stretcher Hoop	1
23	STR0500-133	Back Rest Stop Brace	2
24	STR0500-139	Fowler Release Mechanism Cover	1
25	STABILUS-1	Fowler, Adjustment	2
26	ST0006F13	O2 Holder, Plastic Stretcher	1
27	ST0015	Foot Pedal Tread, Stretcher	6
28	STR0026-05	Lift Pedal "Head End"	1
29	STR0039	Release Pedal "Center"	1
30	STR0036	Release Pedal "Foot End"	1
31	STR0500-66	66" Round Tube, Fifth Wheel Pedal	1
32	ST0031	Pedal, Red	6
33	ST0032	Pedal, Green	6
34	STR0211-P	Painted Brake Pedal Assembly	6
35	ST0006F14	Stretcher Boot	2
36	ST0006F5-02	Chassis Shroud	1
37	ST0005-A	Caster, Tente Directional	1
38	ST0004	Caster, Tente Total Lock	3
39	STR0600	IV Pole Assembly	1
40	ST0058-PT1001	MAC General Transport Stretcher Decal Set (for PT1001 & PT1001-31)	1

## Operation of the PT1001 General Transport Stretcher

### 1. Height Adjustment

- A. The Height Adjustment Mechanism pedals are located on both sides of the stretcher.
- B. Raise the stretcher surface by depressing the height adjustment pedal downward to the floor.
- C. Each time the pedal is depressed, the stretcher will rise. For maximum patient comfort, use long, smooth strokes.



- D. Lower the stretcher by simultaneously depressing the two smaller pedals. The stretcher lowers itself as long as both pedals are depressed, or until reaching lowest position.

### 2. Trendelenburg and Reverse Trendelenburg Position Mechanism

- A. The Trendelenburg mechanism allows  $\pm 18^\circ$  of tilt movement as shown in the first picture at right.
- B. To obtain the Trendelenburg or reverse Trendelenburg positions, first raise the stretcher from lowest position (pedal A).
- C. Then depress pedal B (for head-down Trendelenburg) or pedal C (for foot-down Trendelenburg).
- D. Horizontal level may be regained either by lowering one end until the surface is horizontal, or by activating the height adjustment pedal A. This will raise the stretcher surface to a tilt position until one end reaches maximum height. Continued depression of the height adjustment pedal will then raise the other end to maximum height.

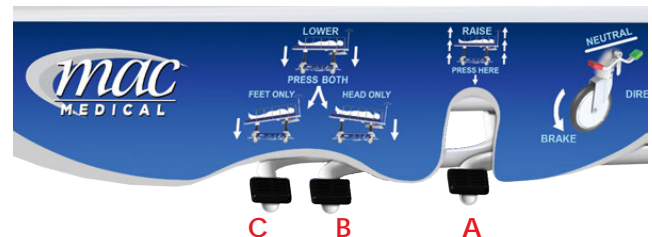



### 3. Casters and Wheel Movement

- A. Casters are central locking type with brake pedals (red) and steering pedals (green) that are located on both stretcher sides, front and rear ends.
- B. Depressing any of the brake pedals will lock the stretcher into position and prevent its movement in any direction.
- C. Depressing any of the green steering pedals will lock the directional caster located at the foot of the stretcher, allowing steering in a straight line.
- D. Horizontal Position (non-depressed pedals) allows all the wheels to swivel and move in any direction.
- E. Place the brake/steering pedal in an horizontal (non-depressed) position to allow all wheels to swivel in any direction for parking maneuvers.
- F. An optional 5th wheel can be added on to allow stretcher movement such as 360° pivot and straight line steering. In attaching the 5th wheel, the directional caster must also be replaced by a swivel caster (ST0004), which is included in the kit on page 15. See "Optional Accessories." Only standard MAC Medical accessories should be used on MAC Medical beds. Use of other non-MAC Medical products may cause damage or malfunction of the structure of the stretcher.
- G. **Caution:** When stretcher is stationary or unattended, lock the wheels.



Brake/Steering Pedals (side view) in horizontal (non-depressed) position

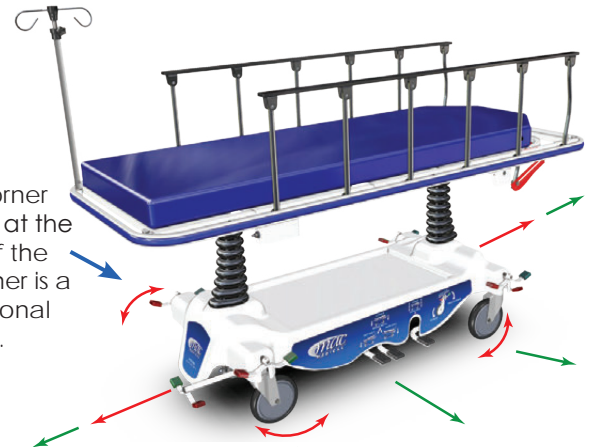

This corner wheel at the foot of the stretcher is a directional caster.

All wheels are capable of directional and pivotal steering (red arrows) in the neutral (undepressed) position.

Brake/Steering Pedals (end view) in horizontal (non-depressed) position



## 4. Back Rest Adjustment

- A. The Back Rest is raised by lifting upward on the red Release Lever located beneath the Back Rest section at the head-end of the stretcher and lifting the Back Rest section of the bed.
- B. The Back Rest can be elevated to a 90° position and adjusted to any incremental position.



Release Lever

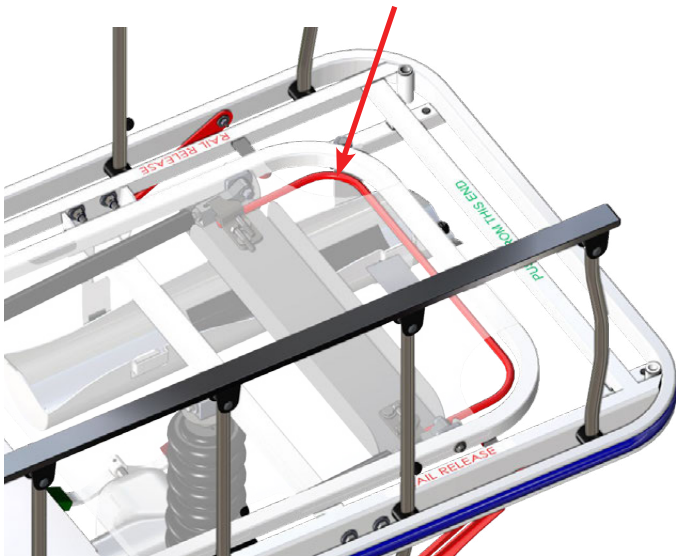

Squeeze up on the red Release Lever to release Back Rest and lift up.

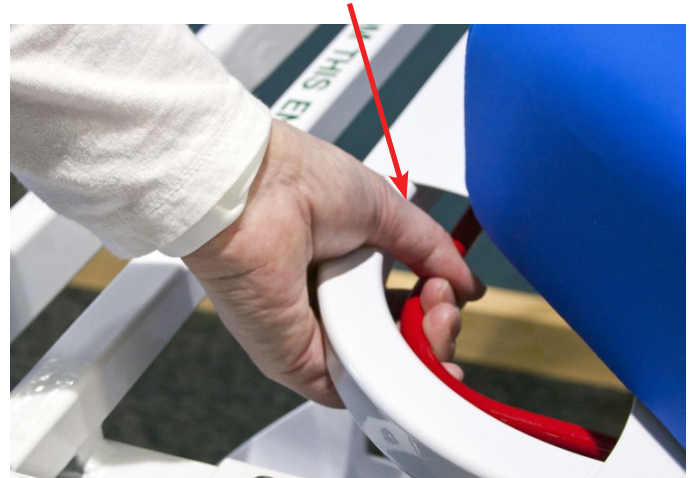

- C. The Back Rest is lowered by squeezing up on the Release Lever and pushing the Back Rest down.
- D. The Back Rest can be fixed in any intermediate position by releasing the release handle when the Back Rest reaches the desired angle of adjustment.

- E. Squeeze up on the Release Lever and push the Back Rest down.



## 5. Rail Adjustment

- A. Side rails are raised from a folded position by simply pulling up the rail and pushing it forward until it locks securely into its fully extended position.

**Caution:** Patients should not be left unattended until it is confirmed that both side rails are locked securely into their fully extended position.



- B. Side Rails are lowered back to their folded position by lifting up the Rail Side Latch rail release (circled in red) with one hand while pushing downward on the rail with the other hand.

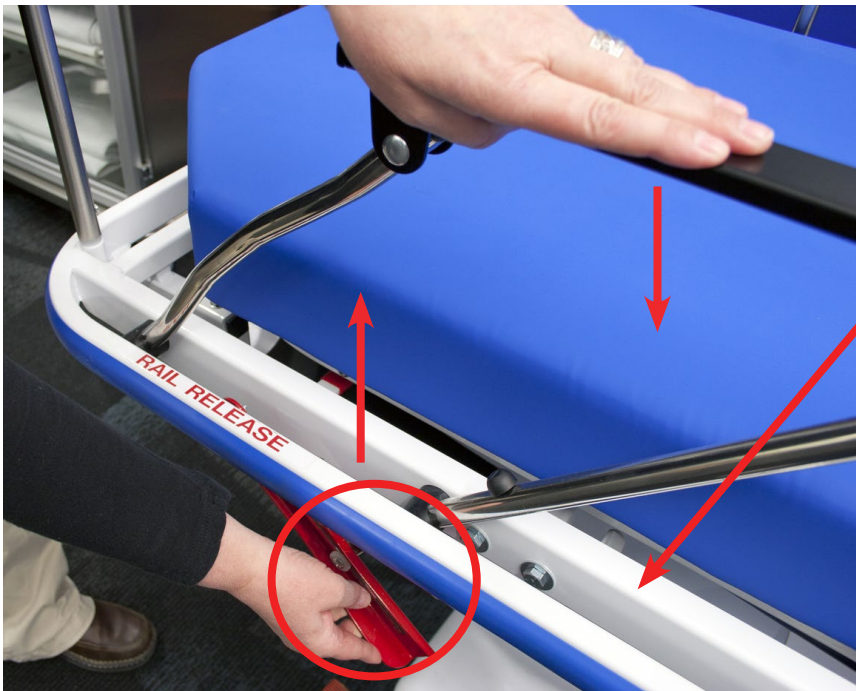

- C. Note: If the rails fall down, tighten the nuts for each rail on the inside of the Support Brace (six places - both sides).

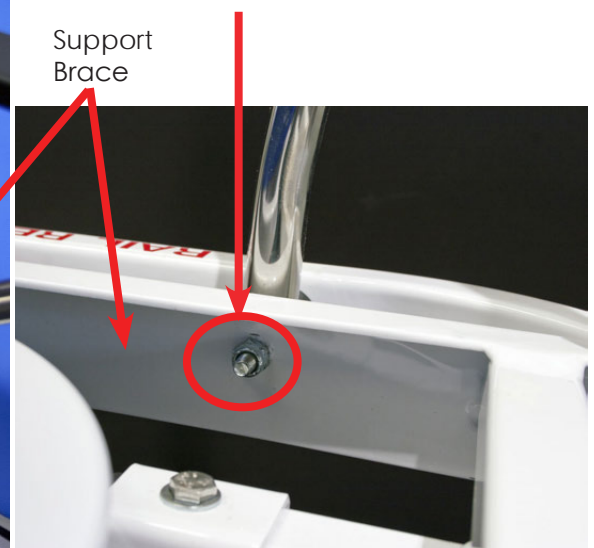



## 6. Other Features

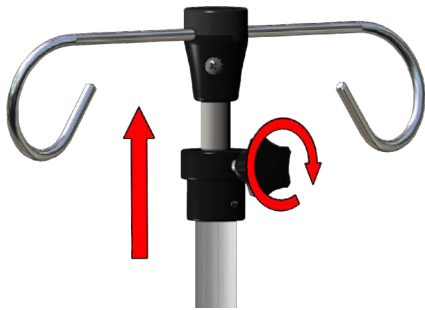

IV poles provided with the stretcher are telescopic. Turn the knob to release the second tube and raise to desired height.

Maximum extension of the pole (from IV hook to mounting stretcher socket) is 43 1/2".

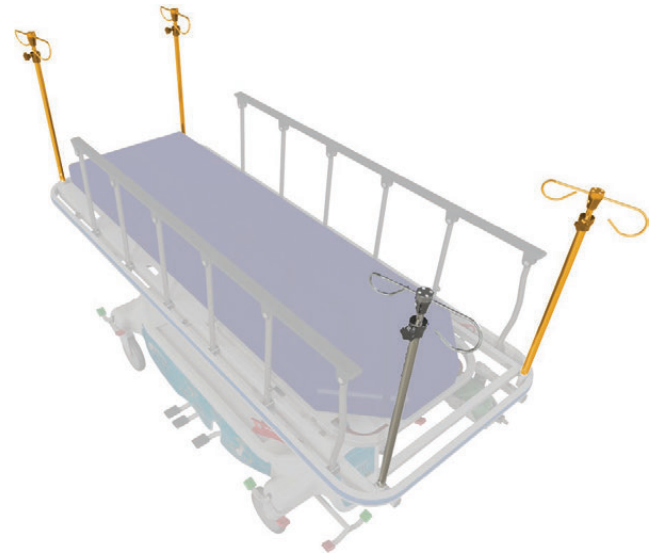

Insert IV poles in any or all of the four IV sockets. Two are located at the foot of the stretcher and two at the head.

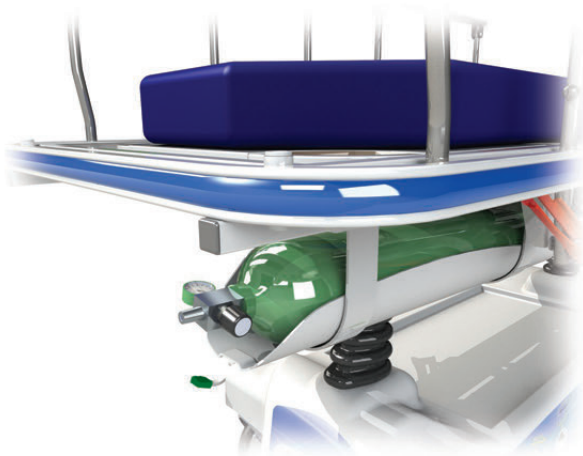

Place oxygen tank in the ergonomically located oxygen tank holder located under the bed frame.

Patient belongings can be stored here for transport.

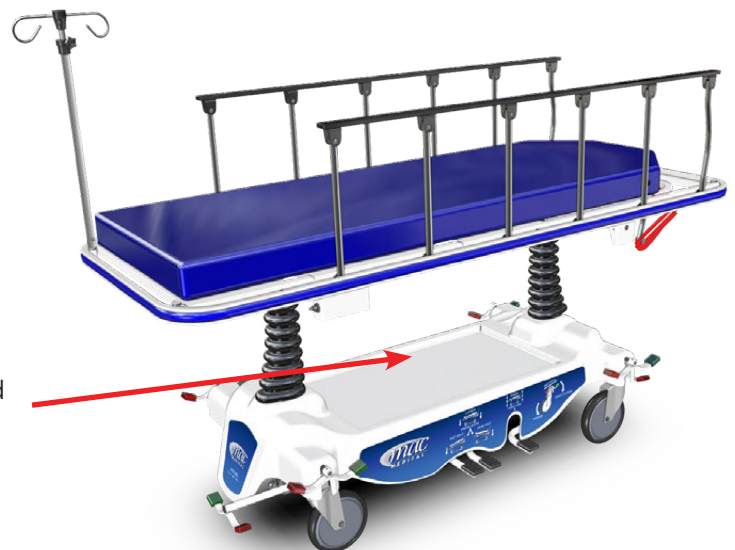

## Fowler Adjustment for PT1001 and PT1001-31 General Transport Stretcher

1. At times, it may be necessary to adjust the Fowlers on the General Transport Stretcher. To do this, first unscrew the four screws securing the Fowler Release Cover.
2. After unscrewing the four screws, remove the Fowler Release Cover.

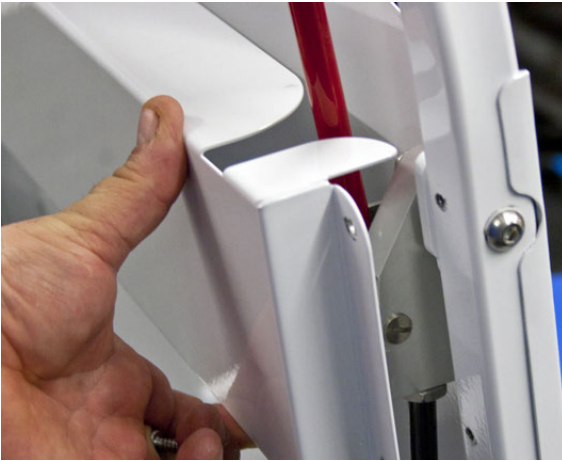

3. A retaining pin is located in this enclosed area, which is located on both sides of the stretcher.
4. Adjust the hex nuts on both Fowlers (red circled area), which will move the retaining pin up or down on the Fowlers.

5. In the views below, the retaining pin can be seen.

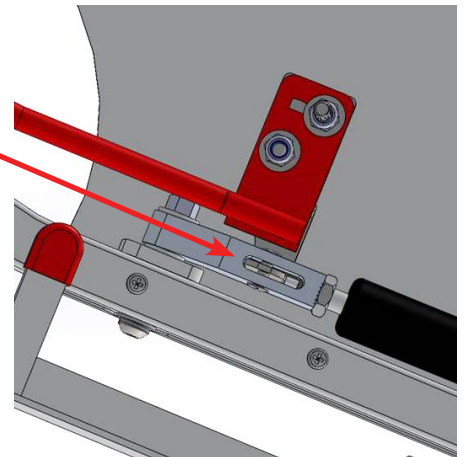
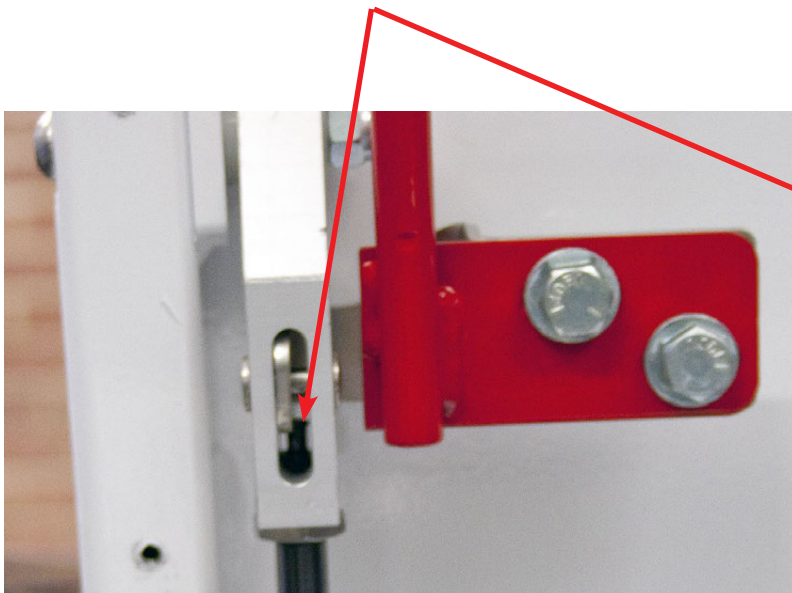

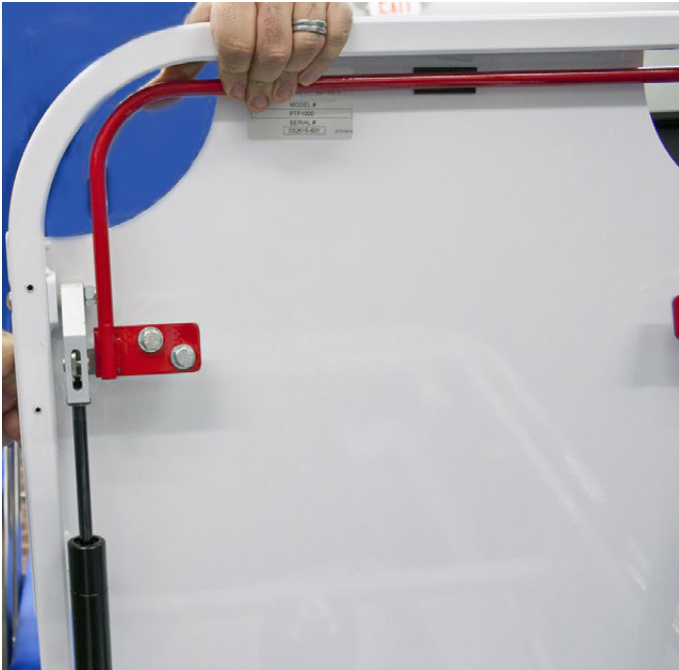

6. When the stretcher Release Lever is pulled back (as shown in the picture at left), the retaining pin is depressed.

7. The picture below shows the retaining pin (in red circle) being depressed by the Release Lever.
8. After adjusting the hex nuts on both Fowlers, reinstall the Fowler Release Cover.





## Stretcher Optional Features

29" or 31" Stretchers may be ordered to include these features:

PH = Fold Down Push Handles

K = Knee Gatch

Example: To order PT1001 with Knee Gatch and Push Handles features use model #PT1001-K-PH.

The same for PT1001-31 would be PT1001-31-K-PH.

Optional Accessories: Only standard MAC Medical accessories should be used on MAC Medical beds. Use of other non-MAC Medical products may cause damage or malfunction of the structure of the stretcher.

Part #	Description
ST0010	Fold Down Push Handles
STRO273	Paper Roll Dispenser Kit
STRO402-11	Detachable Foot Board
ST0122 (Set)	Envelope Style Stretcher Rail Bumper Pads
PT-5W-KIT	5th Wheel Add-on Kit (which includes ST0004 swivel caster)

## Maintenance

### 1. Maintenance - Every Two Months

- Check all components, height adjustment mechanisms, back rest and leg rest adjustments, side rails, casters and brakes, head and foot boards, Trendelenburg mechanism, and make sure all plastic parts are fitted and not broken.
- The mattress surface should be checked to see that it is dry, without any remains of food, urine, blood, etc.
- The mattress should be checked to ensure that it is not torn or split and that it is not permitting urine to leak through onto the mattress surface.
- Should any signs of corrosion be observed, the manufacturer should be advised immediately in order to obtain preventive instructions.
- Any defects should be repaired at once.

### 2. Maintenance - Six Month Check



- Repeat the checks carried out every two months.
- In addition, any chips, cracks or scratches on the paintwork should be repaired/touched up by paint brush in order to prevent the spread of corrosion.
- Casters should be checked and accumulated hair, etc. removed from inside the wheels. The

outside wheel cover should be opened and the caster lightly greased with silicon based grease.

### 3. Maintenance - General

- It is recommended that all beds be numbered and marked so that the maintenance operations can be recorded for each bed in a card index.
- Use a lubricant on the moving parts to allow free movement of sliding parts and help reduce noise.

## Cleaning

- All bed parts may be cleaned by use of a soft cloth or sponge, soap and water.
-  **Caution: In no circumstances should a cleaning agent containing chlorine be used.** MAC Medical does not recommend using any type of bleach as a disinfectant as bleach is highly corrosive and would lead to rusting. For cleaning we recommend using a sporicidal disinfectant, which contains a blend of Peracetic Acid, Hydrogen Peroxide and Acetic Acid. These can be used as sterilants, sporicides, sanitizers or broad-spectrum disinfectants for fast and effective microbial control.
- **NOTE:** All chemical/solutions must be diluted to the manufacturer's recommendations. No chemical or solution should be left to dry on the pad surface. After the allotted time has passed to ensure disinfection, the pad surface should be wiped again with a wet cloth to remove any remaining chemical or solution.
-  **Warning: Do not submerge, sterilize or hose down the mattress pad at any time. This could result in damage to the mattress pad.**
- **Wait 10 – 15 minutes until the mattress surface is completely dry before replacing the mattress.**
- Ensure that traces of blood, urine, iodine and food waste are cleaned as soon as possible to prevent any development of corrosion – particularly underneath the mattress.
- Cleaning of the mattress should be carried out according to the instructions on the mattress care label.
- Materials such as "Scotch-Brite," steel wool or similar abrasives, which may damage the protective paint surface, **should not be used.**
- After washing, stretchers should be placed at an incline of at least 4 degrees for drying.

## Transportation and Storage Conditions

Ambient temperature range: -30°C to +60°C (-22°F to 140°F)  
Relative Humidity 10% to 90% (non-condensing)  
Atmospheric Pressure 500 hPa to 1060 hPa (0.49 atm to 1.05 atm)

## Transportation Damage and Claims

All MAC Medical, Inc., equipment is sold F.O.B. shipping point, and when accepted by the carrier, such shipments become the property of consignee. Should damage occur in shipment, it is a matter between the carrier and the consignee. In such cases, the carrier is assumed to be responsible for the safe delivery of the merchandise, unless negligence can be established on the part of the shipper.

1. Make an immediate inspection while the equipment is still in the truck or immediately after it is moved to the receiving area. Do not wait until after the material is moved to a storage area.
2. Do not sign a delivery receipt or a freight bill until you have made a proper count and inspection of all merchandise received.
3. Note all damage to packages directly on the carrier's delivery receipt.
4. Make certain the driver signs this receipt. If he refuses to sign, make a notation of this refusal on the receipt.
5. If the driver refuses to allow inspection, write the following on the delivery receipt: Driver refuses to allow inspection of containers for visible damage.
6. Telephone the carrier's office immediately upon finding damage, and request an inspection. Mail a written confirmation of the time, date and the person called.
7. Save any packages and packing material for further inspection by the carrier.
8. Promptly file a written claim with the carrier and attach copies of all supporting paperwork.

We will continue our policy to assisting our customers in collecting claims which have been properly filed and actively pursued. We cannot, however, file any damage claims for you, assume the responsibility of any claims or accept deductions in payment for such claims.

## Maintenance Record

For your convenience, here is a simple chart to use to note which personnel have been trained to safely use and maintain the stretcher.

Personnel Trained	Daily Operation	Safety Instruction	Cleaning Procedures

This chart refers to the procedures on page 15.

Date of Weekly Inspection	Date of Monthly Inspection	Date of Semi-Annual Testing



# Warranty Information



## Limited Lifetime Warranty

MAC Medical warrants to the original purchaser that its Proprietary Products will be free from defects in workmanship or materials under normal use and service for the life of the product, so long as owned by the original purchaser, according to the limitations set forth below. Defective products shall be repaired or replaced at MAC Medical's option at no cost to the original purchaser provided:

1. The customer must obtain a written return authorization supplied by MAC Medical's customer service department. The product must be returned, properly packaged, with a copy of the original sales receipt and copy of the RMA authorization. Please call (877) 828-9975 or (618) 476-3550 to receive a return authorization.
2. The customer must pre-pay freight charges to and from MAC Medical and must ship merchandise properly packaged, in a way the product will not be damaged during transit to the factory. MAC Medical does not warranty any freight damage to or from the factory. It is the customer's responsibility to inspect the product for packaging damage before signing the BOL.

This warranty does not apply to products, which have been subject to abuse, misuse, accident, modification, alteration, tampering, negligence, lack of routine maintenance or misapplication; or products that have been repaired by other than MAC Medical or its authorized representatives.

This warranty does not apply to glass, fabrics, vinyl, seat coverings, cushions, padding or their stitching, gluing or installation. Component parts not manufactured by MAC Medical, such as casters, caster inserts, any components made from rubber or plastic, circuit boards, fan heaters, plumbing parts, electrical switches and other components are also excluded. For these component parts, MAC Medical will pass on the original manufacturer's warranty to MAC Medical equipment original purchasers. Please consult factory for questions regarding the warranties of these component parts. This warranty does not apply to custom fabricated products. Consult factory.

UNLESS EXPRESSLY SET FORTH IN THIS WARRANTY, THERE ARE NO OTHER WARRANTIES, WHETHER EXPRESS OR IMPLIED, OF FITNESS AND / OR MERCHANTABILITY OR ANY OTHER WARRANTY IMPLIED BY CUSTOM, USAGE OR COURSE OF DEALING.

Liability of MAC Medical under this warranty is limited to the repair and / or replacement of any products. MAC Medical specifically excludes and disclaims any responsibility for any incidental or consequential damages claimed to have arisen from any defect in workmanship or materials. No representative has any authority to change or enlarge the above warranty or MAC Medical liability. This supersedes all previous warranty provisions.

To place an order, contact our customer service department at **618-476-3550** or **877-828-9975** or by email at [sales@macmedical.com](mailto:sales@macmedical.com)

**MADE USA**  
IN THE

INSPIRED  
TO BE BETTER

*Customer needs are our first priority.*

MAC Medical, Inc.  
Publication No. MAN-037 Rev F  
March 2025

Information regarding this product is subject to change without prior notice.



**Corporate Office**  
200 Admiral Weinel Blvd.  
Columbia, Illinois 62236

**Manufacturing Plant**  
820 South Mulberry Street  
Millstadt, IL 62260

Phone: 618-476-3550 • Toll Free: 877-828-9975 • [www.macmedical.com](http://www.macmedical.com)